

ENGINEERED PRODUCTS CO.

Architectural & Functional Hardware Products



75
SINCE 1941
YEARS

CATALOG No. 33

WWW.EPCOHARDWARE.COM

CONTENTS

1-26	HANDLES & KNOBS
27-34	CATCHES AND TOUCH LATCHES
35-42	TUBING AND CLOSET HARDWARE
43-44	COAT AND HAT HOOKS
45-56	SLIDING DOOR TRACK AND ACCESSORIES
57-60	MIRROR AND GLASS EXTRUSION
61-62	SHELF SUPPORTS AND MIRROR CLIPS
63-64	GLASS DOOR HARDWARE
65-68	OTHER FUNCTIONAL HARDWARE
69	CONDITIONS OF SALE

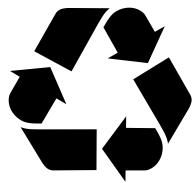

GREENBUILD

EPCO has long been committed to helping all design and construction professionals incorporate sustainable practices into their work. We are proud that many of our products are environmentally friendly because they are recyclable or contain recycled content.

Architectural Stainless Steel Collection



AS50

PART NUMBER	CC	OVERALL LENGTH
AS50-096-SS	96mm	106mm
AS50-128-SS	128mm	138mm
AS50-192-SS	192mm	202mm
AS50-256-SS	256mm	266mm
AS50-320-SS	320mm	330mm



AS51

PART NUMBER	CC	OVERALL LENGTH
AS51-096-SS	96mm	108mm
AS51-128-SS	128mm	140mm
AS51-192-SS	192mm	204mm
AS51-256-SS	256mm	268mm
AS51-320-SS	320mm	332mm



AS52

PART NUMBER	CC	OVERALL LENGTH
AS52-096-SS	96mm	188mm
AS52-128-SS	128mm	220mm
AS52-192-SS	192mm	284mm
AS52-256-SS	256mm	348mm
AS52-320-SS	320mm	412mm
AS52-480-SS	480mm	572mm



AS53

PART NUMBER	CC	OVERALL LENGTH
AS53-096-SS	96mm	108mm
AS53-128-SS	128mm	140mm
AS53-192-SS	192mm	204mm
AS53-256-SS	256mm	268mm
AS53-320-SS	320mm	332mm



AS54

PART NUMBER	CC	OVERALL LENGTH
AS54-096-SS	96mm	136mm
AS54-128-SS	128mm	168mm
AS54-192-SS	192mm	232mm
AS54-256-SS	256mm	296mm
AS54-320-SS	320mm	360mm
AS54-480-SS	480mm	520mm



AS55

Satin Nickel Steel

PART NUMBER	CC	OVERALL LENGTH
AS55-096-SN	96mm	109mm
AS55-128-SN	128mm	141mm
AS55-192-SN	192mm	205mm
AS55-256-SN	256mm	269mm
AS55-320-SN	320mm	333mm

• Steel pull with a Satin Nickel finish

Architectural Stainless Steel Collection

HANDLES & KNOBS

AS20

PART NUMBER	PROJECTION	DIAMETER	MATERIAL
AS20	30mm	20mm	Stainless Steel



AS38

PART NUMBER	PROJECTION	DIAMETER	MATERIAL
AS38-18	30mm	18mm	Stainless Steel
AS38-20	30mm	20mm	Stainless Steel



AS39

PART NUMBER	PROJECTION	DIAMETER	MATERIAL
AS39	30mm	32mm	Stainless Steel



KP-30-SS

PART NUMBER	PROJECTION	DIAMETER	MATERIAL
KP30-SS	35mm (1.38in)	30mm (1.18in)	Stainless Steel



KP-31-SS

PART NUMBER	PROJECTION	DIAMETER	MATERIAL
KP31-SS	27mm (1.06in)	31mm (1.22in)	Stainless Steel



AP-SS

PART NUMBER	CC	OVERALL LENGTH	MATERIAL
AP030-SS	3 in. (76mm)	3.62 in. (92mm)	Stainless Steel
AP096-SS	96 mm (3.78 in)	118 mm (4.62in)	Stainless Steel
AP128-SS	128 mm (5.04in)	152 mm (6.00in)	Stainless Steel
AP160-SS	160 mm (6.30in)	190 mm (7.50in)	Stainless Steel
AP192-SS	192 mm (7.56in)	228 mm (9.00in)	Stainless Steel



- Bar diameter: 10mm
- Includes two 8-32 x 1" screws
- Custom sizes available
- 32mm projection

AP-BL

PART NUMBER	CC	OVERALL LENGTH	MATERIAL	FINISH
AP030-BL	3 in. (76mm)	3.62 in. (92mm)	Steel	Satin Black
AP096-BL	96 mm (3.78 in)	118 mm (4.62in)	Steel	Satin Black
AP128-BL	128 mm (5.04in)	152 mm (6.00in)	Steel	Satin Black
AP192-BL	192 mm (7.56in)	228 mm (9.00in)	Steel	Satin Black



- Bar diameter: 10mm
- Includes two 8-32 x 1" screws
- Custom sizes available
- 32mm projection

Bar Pulls

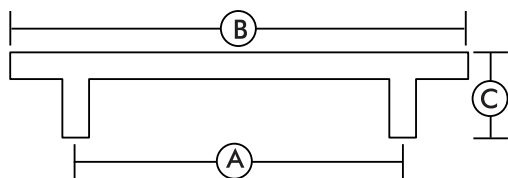

BP-SS

PART NUMBER	CC (A)	OVERALL LENGTH (B)	PROJECTION (C)	MATERIAL
BP010-SS	T-knob	60 mm (2.36 in.)	(1 ²⁷ / ₆₄ in.) 35mm	Stainless Steel
BP030-SS	76 mm (3 in.)	140 mm (5.5 in.)	(1 ²⁷ / ₆₄ in.) 35mm	Stainless Steel
BP03.5-SS	89 mm (3.5 in)	152 mm (6.0 in)	(1 ²⁷ / ₆₄ in.) 35mm	Stainless Steel
BP096-SS	96 mm (3.78 in)	156 mm (6.14 in)	(1 ²⁷ / ₆₄ in.) 35mm	Stainless Steel
BP128-SS	128 mm (5.04 in)	188 mm (7.40 in)	(1 ²⁷ / ₆₄ in.) 35mm	Stainless Steel
BP192-SS	192mm (7.56 in)	252mm (9.84 in)	(1 ²⁷ / ₆₄ in.) 35mm	Stainless Steel
BP256-SS	256 mm (10.08 in)	336 mm (13.23 in)	(1 ²⁷ / ₆₄ in.) 35mm	Stainless Steel
BP320-SS	320 mm (12.60 in)	400 mm (15.75in)	(1 ²⁷ / ₆₄ in.) 35mm	Stainless Steel
BP416-SS	416 mm (16.38 in)	496 mm (19.53 in)	(1 ²⁷ / ₆₄ in.) 35mm	Stainless Steel
BP480-SS	480 mm (18.90 in)	560 mm (22.05 in)	(1 ²⁷ / ₆₄ in.) 35mm	Stainless Steel
BP544-SS	544 mm (21.42 in)	624 mm (24.57 in)	(1 ²⁷ / ₆₄ in.) 35mm	Stainless Steel
BP640-SS	640 mm (25.20 in)	720 mm (28.35 in)	(1 ²⁷ / ₆₄ in.) 35mm	Stainless Steel
BP768-SS	768 mm (30.24 in)	848 mm (33.39 in)	(1 ²⁷ / ₆₄ in.) 35mm	Stainless Steel

- Includes two 8-32 x 1" stainless steel screws individually polybagged
- Projection, drawer face to front edge of pull: 35mm (1²⁷/₆₄"
- Bar diameter: 12 mm (1⁵/₃₂"
- Gap between drawer face and pull: 23 mm (2⁹/₃₂"
- Leg diameter: 10mm (2⁵/₆₄"
- Solid type 304 stainless steel
- Custom sizes available



BP-SN

PART NUMBER	CC (A)	OVERALL LENGTH (B)	PROJECTION (C)	MATERIAL	FINISH
BP010-SN	T-knob	60 mm (2.36 in.)	(1 ²⁷ / ₆₄ in.) 35mm	Steel	Satin Nickel
BP030-SN	76 mm (3 in.)	140 mm (5.5 in.)	(1 ²⁷ / ₆₄ in.) 35mm	Steel	Satin Nickel
BP03.5-SN	89 mm (3.5 in)	152 mm (6.0 in)	(1 ²⁷ / ₆₄ in.) 35mm	Steel	Satin Nickel
BP096-SN	96 mm (3.78 in)	156 mm (6.14 in)	(1 ²⁷ / ₆₄ in.) 35mm	Steel	Satin Nickel
BP128-SN	128 mm (5.04 in)	188 mm (7.40 in)	(1 ²⁷ / ₆₄ in.) 35mm	Steel	Satin Nickel
BP192-SN	192mm (7.56 in)	252mm (9.84 in)	(1 ²⁷ / ₆₄ in.) 35mm	Steel	Satin Nickel
BP256-SN	256 mm (10.08 in)	336 mm (13.23 in)	(1 ²⁷ / ₆₄ in.) 35mm	Steel	Satin Nickel
BP320-SN	320 mm (12.60 in)	400 mm (15.75in)	(1 ²⁷ / ₆₄ in.) 35mm	Steel	Satin Nickel

- Galvanically protected satin nickel steel bar pull
- Copper plated, brass plated, twice nickel plated
- Includes two 8-32 x 1" steel screws
- Projection, drawer face to front edge of pull: 35 mm (1²⁷/₆₄"
- Bar diameter: 12 mm (1⁵/₃₂"
- Gap between drawer face and pull: 23 mm (2⁹/₃₂"
- Leg diameter: 10mm (2⁵/₆₄"



BP-VB		CC (A)	OVERALL LENGTH (B)	PROJECTION (C)	MATERIAL	FINISH
PART NUMBER						
BP010-VB	T-knob		60 mm (2.36 in.)	(1 ²⁷ / ₆₄ in.) 35mm	Steel	Venetian Bronze
BP030-VB	76 mm (3 in.)		140 mm (5.5 in.)	(1 ²⁷ / ₆₄ in.) 35mm	Steel	Venetian Bronze
BP096-VB	96 mm (3.78 in)		156 mm (6.14 in)	(1 ²⁷ / ₆₄ in.) 35mm	Steel	Venetian Bronze
BP192-VB	192mm (7.56 in)		252mm (9.84 in)	(1 ²⁷ / ₆₄ in.) 35mm	Steel	Venetian Bronze
BP256-VB	256 mm (10.08 in)		336 mm (13.23 in)	(1 ²⁷ / ₆₄ in.) 35mm	Steel	Venetian Bronze
BP320-VB	320 mm (12.60 in)		400 mm (15.75in)	(1 ²⁷ / ₆₄ in.) 35mm	Steel	Venetian Bronze

- Bar diameter: 12 mm (15/32")
- Gap between drawer face and pull: 23 mm (29/32")
- Leg diameter: 10mm (25/64")
- Includes two 8-32 x 1" steel screws



BP-ORB		CC (A)	OVERALL LENGTH (B)	PROJECTION (C)	MATERIAL	FINISH
PART NUMBER						
BP010-ORB	T-knob		60 mm (2.36 in.)	(1 ²⁷ / ₆₄ in.) 35mm	Steel	Oil Rub Bronze
BP030-ORB	76 mm (3 in.)		140 mm (5.5 in.)	(1 ²⁷ / ₆₄ in.) 35mm	Steel	Oil Rub Bronze
BP096-ORB	96 mm (3.78 in)		156 mm (6.14 in)	(1 ²⁷ / ₆₄ in.) 35mm	Steel	Oil Rub Bronze
BP128-ORB	128 mm (5.04in)		188 mm (7.40 in)	(1 ²⁷ / ₆₄ in.) 35mm	Steel	Oil Rub Bronze
BP192-ORB	192mm (7.56 in)		252mm (9.84 in)	(1 ²⁷ / ₆₄ in.) 35mm	Steel	Oil Rub Bronze
BP256-ORB	256 mm (10.08 in)		336 mm (13.23 in)	(1 ²⁷ / ₆₄ in.) 35mm	Steel	Oil Rub Bronze
BP320-ORB	320 mm (12.60 in)		400 mm (15.75in)	(1 ²⁷ / ₆₄ in.) 35mm	Steel	Oil Rub Bronze

- Bar diameter: 12 mm (15/32")
- Gap between drawer face and pull: 23 mm (29/32")
- Leg diameter: 10mm (25/64")
- Includes two 8-32 x 1" steel screws



KP-31-ORB

PART NUMBER	PROJECTION	DIAMETER
KP31-ORB	27mm (1.06in)	31mm (1.22in)



KP-32-ORB

PART NUMBER	PROJECTION	DIAMETER
KP32-ORB	27mm (1.06in)	22 x 32mm



Architectural Aluminum Collection



A
Satin Clear
Anodized



SS
Anodized
Stainless

HANDLES & KNOBS



AC2138

PART NUMBER	CC	OVERALL LENGTH	MATERIAL	FINISH
AC2138-96-SS	96mm	114mm	Aluminum	SS
AC2138-128-SS	128mm	150mm	Aluminum	SS
AC2138-160-SS	160mm	187mm	Aluminum	SS
AC2138-192-SS	192mm	217mm	Aluminum	SS
AC2138-224-SS	224mm	250mm	Aluminum	SS
AC2138-320-SS	320mm	354mm	Aluminum	SS

- Includes two 8-32 thread screws



AC2137

PART NUMBER	CC	OVERALL LENGTH	MATERIAL	FINISH
AC2137-096-SS	96mm	109mm	Aluminum	SS
AC2137-128-SS	128mm	147mm	Aluminum	SS
AC2137-160-SS	160mm	179mm	Aluminum	SS
AC2137-192-SS	192mm	212mm	Aluminum	SS
AC2137-224-SS	224mm	244mm	Aluminum	SS

- Includes two 8-32 thread screws



AC2130

PART NUMBER	CC	OVERALL LENGTH	MATERIAL	FINISH
AC2130-096-SS	96mm	110mm	Aluminum	SS
AC2130-128-SS	128mm	143mm	Aluminum	SS
AC2130-160-SS	160mm	174mm	Aluminum	SS
AC2130-192-SS	192mm	206mm	Aluminum	SS
AC2130-224-SS	224mm	239mm	Aluminum	SS

- Includes two 8-32 thread screws



AC367084

PART NUMBER	DIAMETER	MATERIAL	FINISH
AC367084-25-A	25mm	Aluminum	A
AC367084-30-A	30mm	Aluminum	A
AC367084-35-A	35mm	Aluminum	A

- Includes 8-32 thread screw

AC1222

PART NUMBER	CC	OVERALL LENGTH	MATERIAL	FINISH
AC1222-128-A	128mm	138mm	Aluminum	A
AC1222-160-A	160mm	170mm	Aluminum	A
AC1222-224-A	224mm	234mm	Aluminum	A
AC1222-288-A	288mm	298mm	Aluminum	A
AC1222-352-A	352mm	362mm	Aluminum	A
AC1222-480-A	480mm	490mm	Aluminum	A

- Includes two 8-32 thread screws



AC1232

PART NUMBER	CC	OVERALL LENGTH	MATERIAL	FINISH
AC1232-128-A	128mm	141mm	Aluminum	A
AC1232-160-A	160mm	173mm	Aluminum	A
AC1232-192-A	192mm	205mm	Aluminum	A
AC1232-224-A	224mm	237mm	Aluminum	A

Special order
screw set mount

AC1232-288-A	288mm	301mm	Aluminum	A
AC1232-352-A	352mm	365mm	Aluminum	A

- Includes two 8-32 thread screws



AC2134

PART NUMBER	CC	OVERALL LENGTH	MATERIAL	FINISH
AC2134-160-A	160mm	189mm	Aluminum	A
AC2134-192-A	192mm	227mm	Aluminum	A
AC2134-224-A	224mm	254mm	Aluminum	A
AC2134-288-A	288mm	341mm	Aluminum	A
AC2134-352-A	352mm	417mm	Aluminum	A

- Includes two 8-32 thread screws



AC3541

PART NUMBER	CC	OVERALL LENGTH	MATERIAL	FINISH
AC3541-32-A	32mm	56mm	Aluminum	A
AC3541-64-A	64mm	88mm	Aluminum	A
AC3541-128-A	128mm	152mm	Aluminum	A
AC3541-160-A	160mm	184mm	Aluminum	A
AC3541-224-A	224mm	248mm	Aluminum	A

- Includes two 8-32 thread screws



AC3822

PART NUMBER	CC	OVERALL LENGTH	MATERIAL	FINISH
AC3822-160-A	160mm	180mm	Aluminum	A
AC3822-192-A	192mm	212mm	Aluminum	A
AC3822-224-A	224mm	244mm	Aluminum	A
AC3822-288-A	288mm	308mm	Aluminum	A
AC3822-352-A	352mm	372mm	Aluminum	A

- Includes two 8-32 thread screws



Architectural Aluminum Collection



KP20

PART NUMBER	PROJECTION	MATERIAL	FINISH
KP20-DC	7/8"	Zinc	Dull Chrome
KP20-ORB	7/8"	Zinc	Oil Rubbed Bronze
KP20-SN	7/8"	Zinc	Satin Nickel

- 3/4" square knob
- Includes 8-32 thread screw

DP48

PART NUMBER	CC	OVERALL LENGTH	FINISH
DP48-DC	1 7/16"	2"	Dull Chrome
DP48-ORB	1 7/16"	2"	Oil Rubbed Bronze
DP48-SN	1 7/16"	2"	Satin Nickel

- Projection: 1 7/16"
- Material: zinc
- Includes 8-32 thread screw



DP49

PART NUMBER	PROJECTION	MATERIAL	FINISH
DP49-SS	15/16"	Aluminum	Stainless Steel
DP49-ORB	15/16"	Aluminum	Oil Rubbed Bronze
DP49-DC	15/16"	Aluminum	Dull Chrome

- Includes one 8-32 x 1" screws
- Material thickness: 1/4"
- 3/4" high



Aluminum Architectural Drawer and Door Pulls

DP40

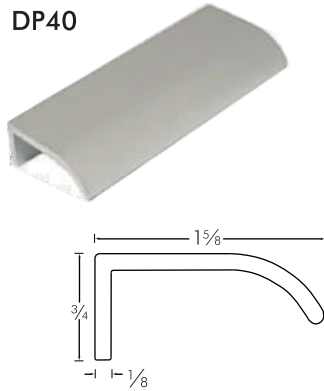

PART NUMBER	CC	OVERALL LENGTH	SCREWS	FINISH
DP40-A	1 7/8"	3 7/8"	#6 x 5/8"	A
DP40-B	1 7/8"	3 7/8"	#6 x 5/8"	B
DP40-BL	1 7/8"	3 7/8"	#6 x 5/8"	BL
DP40-BZ	1 7/8"	3 7/8"	#6 x 5/8"	BZ
DP40-ORB	1 7/8"	3 7/8"	#6 x 5/8"	ORB
DP40-A-1.5	1"	1 1/2"	#6 x 5/8"	A
DP40-B-1.5	1"	1 1/2"	#6 x 5/8"	B
DP40-BL-1.5	1"	1 1/2"	#6 x 5/8"	BL
DP40-BZ-1.5	1"	1 1/2"	#6 x 5/8"	BZ
DP40-ORB-1.5	1"	1 1/2"	#6 x 5/8"	ORB
DP40-L-A	no holes	6'	no screws	A

- For material thickness of 1/2" to 7/8"
- Material: Aluminum
- Back mounting
- Custom sizes available

DP41

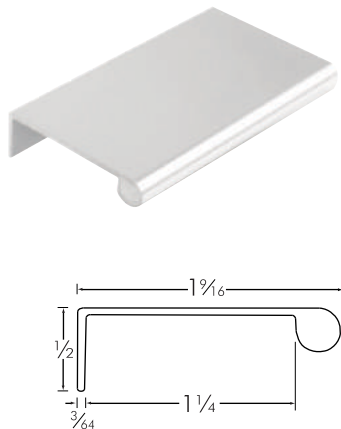

PART NUMBER	CC	OVERALL LENGTH	SCREWS	FINISH
DP41-A	1"	1 1/2"	#6 x 5/8"	A
DP41-SS	1"	1 1/2"	#6 x 5/8"	SS
DP41-B	1"	1 1/2"	#6 x 5/8"	B
DP41-BL	1"	1 1/2"	#6 x 5/8"	BL
DP41-BZ	1"	1 1/2"	#6 x 5/8"	BZ
DP41-ORB	1"	1 1/2"	#6 x 5/8"	ORB
DP41-PA	1"	1 1/2"	#6 x 5/8"	PA
DP41-PB	1"	1 1/2"	#6 x 5/8"	PB
DP41-PBL	1"	1 1/2"	#6 x 5/8"	PBL
DP41-WH	1"	1 1/2"	#6 x 5/8"	WH
DP41-A-3	2"	3"	#6 x 5/8"	A
DP41-SS-3	2"	3"	#6 x 5/8"	SS
DP41-B-3	2"	3"	#6 x 5/8"	B
DP41-BL-3	2"	3"	#6 x 5/8"	BL
DP41-BZ-3	2"	3"	#6 x 5/8"	BZ
DP41-ORB-3	2"	3"	#6 x 5/8"	ORB
DP41-PA-3	2"	3"	#6 x 5/8"	PA
DP41-PB-3	2"	3"	#6 x 5/8"	PB
DP41-WH-3	2"	3"	#6 x 5/8"	WH
DP41-A-4	2"	4"	#6 x 5/8"	A
DP41-SS-4	2"	4"	#6 x 5/8"	SS
DP41-B-4	2"	4"	#6 x 5/8"	B
DP41-BL-4	2"	4"	#6 x 5/8"	BL
DP41-BZ-4	2"	4"	#6 x 5/8"	BZ
DP41-ORB-4	2"	4"	#6 x 5/8"	ORB
DP41-PA-4	2"	4"	#6 x 5/8"	PA
DP41-A-6	4"	6"	#6 x 5/8"	A
DP41-SS-6	4"	6"	#6 x 5/8"	SS
DP41-B-6	4"	6"	#6 x 5/8"	B
DP41-BL-6	4"	6"	#6 x 5/8"	BL
DP41-BZ-6	4"	6"	#6 x 5/8"	BZ
DP41-ORB-6	4"	6"	#6 x 5/8"	ORB
DP41-PA-6	4"	6"	#6 x 5/8"	PA
DP41-WH-6	4"	6"	#6 x 5/8"	WH
DP41-L-A	no holes	6'	no screws	A
DP41-L-SS	no holes	6'	no screws	SS
DP41-L-BL	no holes	6'	no screws	BL
DP41-L-M	no holes	6'	no screws	M
DP41-L-PA	no holes	6'	no screws	PA

- For material thickness of 1/2" to 7/8"
- Material: Aluminum
- Back mounting
- Custom sizes available

1 1/2", 3", 4" and 6" pulls are polybagged with screws. 6' pulls are individually polybagged.

Aluminum Architectural Drawer and Door Pulls



Satin Clear
Anodized



Satin Brass
Anodized



Satin Black
Anodized



Satin Bronze
Anodized



Oil Rubbed
Bronze
Anodized



Polished
Aluminum
Anodized



Polished Brass
Anodized



Gloss Black
Powdercoat



Gloss White
powdercoat



Anodized
Stainless

PART NUMBER	CC	OVERALL LENGTH	SCREWS	FINISH
DP42-A	no holes	1 1/2"	no screws	A
DP42-B	no holes	1 1/2"	no screws	B
DP42-BL	no holes	1 1/2"	no screws	BL
DP42-BZ	no holes	1 1/2"	no screws	BZ
DP42-ORB	no holes	1 1/2"	no screws	ORB
DP42-PA	no holes	1 1/2"	no screws	PA
DP42-A-3	no holes	3"	no screws	A
DP42-B-3	no holes	3"	no screws	B
DP42-BL-3	no holes	3"	no screws	BL
DP42-BZ-3	no holes	3"	no screws	BZ
DP42-ORB-3	no holes	3"	no screws	ORB
DP42-PA-3	no holes	3"	no screws	PA
DP42-L-A	no holes	6'	no screws	A
DP42-L-BL	no holes	6'	no screws	BL
DP42-L-M	no holes	6'	no screws	M
DP42-L-PA	no holes	6'	no screws	PA

DP42

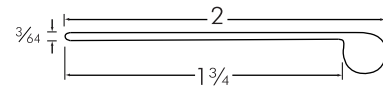
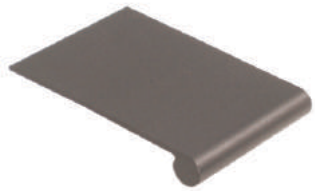

- For material thickness of 5/8" to 1 1/4"
- Material: Aluminum
- Top mounting
- Custom sizes available

Pulls are individually polybagged

PART NUMBER	CC	OVERALL LENGTH	SCREWS	FINISH
DP43-A	1 7/8"	3 7/8"	#6 x 5/8"	A
DP43-B	1 7/8"	3 7/8"	#6 x 5/8"	B
DP43-BL	1 7/8"	3 7/8"	#6 x 5/8"	BL
DP43-BZ	1 7/8"	3 7/8"	#6 x 5/8"	BZ
DP43-ORB	1 7/8"	3 7/8"	#6 x 5/8"	ORB
DP43-L-A	no holes	6'	no screws	A
DP43-L-M	no holes	6'	no screws	M

DP43

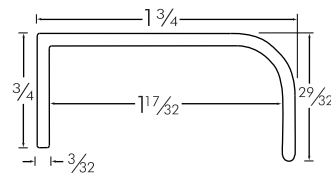

- For material thickness of 1/2" to 7/8"
- Material: Aluminum
- Back mounting
- Custom sizes available

3 7/8" pulls are polybagged with two screws.

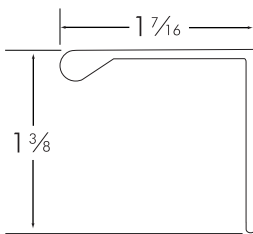

DP44

PART NUMBER	CC	OVERALL LENGTH	SCREWS	FINISH
DP44-BL	1 1/4"	2"	#6 x 3/4"	BL
DP44-DC	1 1/4"	2"	#6 x 3/4"	DC
DP44-ORB	1 1/4"	2"	#6 x 3/4"	ORB
DP44-PB	1 1/4"	2"	#6 x 3/4"	PB
DP44-PC	1 1/4"	2"	#6 x 3/4"	PC
DP44-SN	1 1/4"	2"	#6 x 3/4"	SN

- Material: Zinc
- 2mm material thickness
- Back mounting
- 4 screw holes. Polybagged with screws.

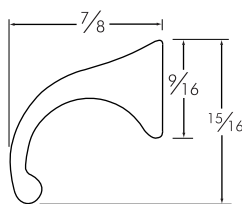

DP45

PART NUMBER	CC	OVERALL LENGTH	SCREWS	FINISH
DP45-A	3"	3 7/8"	8-32 x 1"	A
DP45-B	3"	3 7/8"	8-32 x 1"	B
DP45-BL	3"	3 7/8"	8-32 x 1"	BL
DP45-BZ	3"	3 7/8"	8-32 x 1"	BZ
DP45-ORB	3"	3 7/8"	8-32 x 1"	ORB
DP45-L-A	no holes	6'	no screws	A
DP45-L-M	no holes	6'	no screws	M

- Material: Aluminum
- For any material thickness
- Surface mounting
- Custom sizes available

3 7/8" pulls are polybagged with two screws.

SEE PAGE 9 FOR FINISHES

Aluminum Architectural Drawer and Door Pulls

DP46

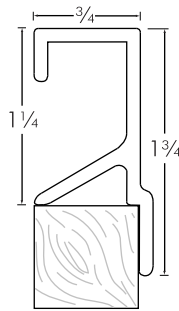

PART NUMBER	CC	OVERALL LENGTH	SCREWS	FINISH
DP46-A	3"	3 7/8"	#6 x 5/8"	A
DP46-B	3"	3 7/8"	#6 x 5/8"	B
DP46-BL	3"	3 7/8"	#6 x 5/8"	BL
DP46-BZ	3"	3 7/8"	#6 x 5/8"	BZ
DP46-ORB	3"	3 7/8"	#6 x 5/8"	ORB
DP46-PA	3"	3 7/8"	#6 x 5/8"	PA
DP46-L-A	no holes	6'	no screws	A
DP46-L-BL	no holes	6'	no screws	BL
DP46-L-ORB	no holes	6'	no screws	ORB
DP46-L-M	no holes	6'	no screws	M
DP46-L-PA	no holes	6'	no screws	PA

- Material: Aluminum
- For material thickness of 3/4"
- Flush mortise mounting
- Custom sizes available

3 7/8" pulls are polybagged with two screws.

DP46-2

PART NUMBER	CC	OVERALL LENGTH	SCREWS	FINISH
DP46-2-A	3"	3 7/8"	#6 x 5/8"	A
DP46-2-B	3"	3 7/8"	#6 x 5/8"	B
DP46-2-BL	3"	3 7/8"	#6 x 5/8"	BL
DP46-2-BZ	3"	3 7/8"	#6 x 5/8"	BZ
DP46-2-ORB	3"	3 7/8"	#6 x 5/8"	ORB
DP46-2-PA	3"	3 7/8"	#6 x 5/8"	PA
DP46-2-L-M	no holes	6'	no screws	M
DP46-2-L-PA	no holes	6'	no screws	PA

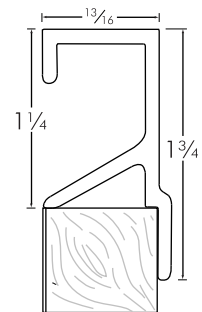
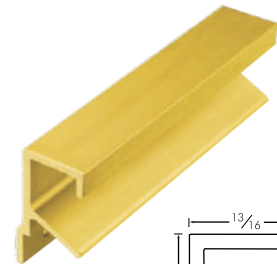

- Material: Aluminum
- For material thickness of 1 3/16"
- Flush mortise mounting
- Custom sizes available

3" pulls are polybagged with two screws.

SEE PAGE 9 FOR FINISHES

Aluminum Architectural Drawer and Door Pulls

HANDLES & KNOBS

DP47

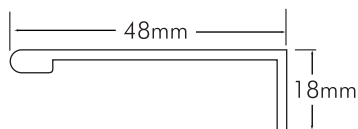
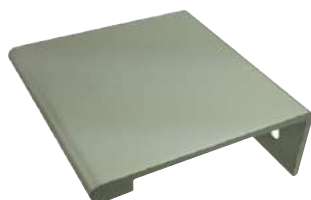

PART NUMBER	CC	OVERALL LENGTH	SCREWS	FINISH
DP47-A	32mm	50mm	#6 x 5/8"	A
DP47-BL	32mm	50mm	#6 x 5/8"	BL
DP47-ORB	32mm	50mm	#6 x 5/8"	ORB
DP47-A-100	77mm	100mm	#6 x 5/8"	A
DP47-BL-100	77mm	100mm	#6 x 5/8"	BL
DP47-ORB-100	77mm	100mm	#6 x 5/8"	ORB
DP47-L-A	no holes	1828mm	no screws	A
DP47-L-M	no holes	1828mm	no screws	M

- For material thickness of 1/2" to 7/8"
- Material: Aluminum
- Back mounted
- Custom sizes available

50mm and 100mm pulls are polybagged with two screws.

DP403

PART NUMBER	CC	OVERALL LENGTH	SCREWS	FINISH
DP403-A	1 7/8"	3 7/8"	#5 x 1/2"	A
DP403-B	1 7/8"	3 7/8"	#5 x 1/2"	B
DP403-BL	1 7/8"	3 7/8"	#5 x 1/2"	BL
DP403-BZ	1 7/8"	3 7/8"	#5 x 1/2"	BZ
DP403-ORB	1 7/8"	3 7/8"	#5 x 1/2"	ORB
DP403-L-A	no holes	6'	no screws	A

- For material thickness of 5/8" to 7/8"
- Material: Aluminum
- Top mounting
- Custom sizes available

3 7/8" pulls are polybagged with two screws.

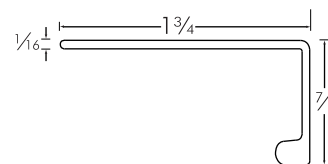

SEE PAGE 9 FOR FINISHES

Aluminum Architectural Drawer and Door Pulls

DP412

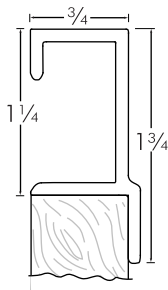
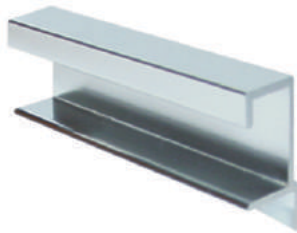

PART NUMBER	CC	OVERALL LENGTH	SCREWS	FINISH
DP412-A	3"	3 7/8"	#6 x 5/8"	A
DP412-B	3"	3 7/8"	#6 x 5/8"	B
DP412-BL	3"	3 7/8"	#6 x 5/8"	BL
DP412-BZ	3"	3 7/8"	#6 x 5/8"	BZ
DP412-ORB	3"	3 7/8"	#6 x 5/8"	ORB
DP412-PA	3"	3 7/8"	#6 x 5/8"	PA
DP412-L-A	no holes	6'	no screws	A
DP412-L-BL	no holes	6'	no screws	BL
DP412-L-M	no holes	6'	no screws	M

- Material: Aluminum
- For material thickness of 3/4"
- Flush mortise mounting
- Custom sizes available

3 7/8" pulls are polybagged with two screws.

DP412-2

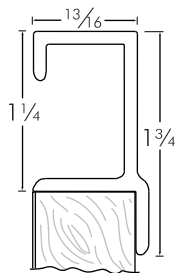
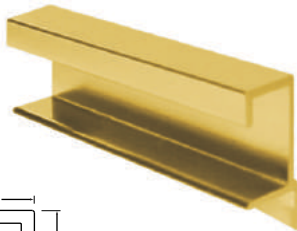

PART NUMBER	CC	OVERALL LENGTH	SCREWS	FINISH
DP412-2-A	3"	3 7/8"	#6 x 5/8"	A
DP412-2-B	3"	3 7/8"	#6 x 5/8"	B
DP412-2-BL	3"	3 7/8"	#6 x 5/8"	BL
DP412-2-BZ	3"	3 7/8"	#6 x 5/8"	BZ
DP412-2-ORB	3"	3 7/8"	#6 x 5/8"	ORB
DP412-2-L-A	no holes	6'	no screws	A
DP412-2-L-M	no holes	6'	no screws	M

- Material: Aluminum
- For material thickness of 13/16"
- Flush mortise mounting
- Custom sizes available

3 7/8" pulls are polybagged with two screws.

SEE PAGE 9 FOR FINISHES

Aluminum Architectural Drawer and Door Pulls

HANDLES & KNOBS

DP413

PART NUMBER	CC	OVERALL LENGTH	SCREWS	FINISH
DP413-A	3"	3 7/8"	#6 x 5/8"	A
DP413-B	3"	3 7/8"	#6 x 5/8"	B
DP413-BL	3"	3 7/8"	#6 x 5/8"	BL
DP413-BZ	3"	3 7/8"	#6 x 5/8"	BZ
DP413-ORB	3"	3 7/8"	#6 x 5/8"	ORB
DP413-PA	3"	3 7/8"	#6 x 5/8"	PA

- Material: Aluminum
- For material thickness of 3/4"
- Flush mortise mounting
- Custom sizes available

3 7/8" pulls are polybagged with two screws.

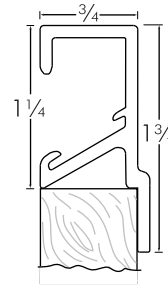
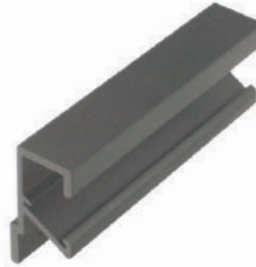

DP413-2

PART NUMBER	CC	OVERALL LENGTH	SCREWS	FINISH
DP413-2-A	3"	3 7/8"	#6 x 5/8"	A
DP413-2-B	3"	3 7/8"	#6 x 5/8"	B
DP413-2-BL	3"	3 7/8"	#6 x 5/8"	BL
DP413-2-BZ	3"	3 7/8"	#6 x 5/8"	BZ
DP413-2-ORB	3"	3 7/8"	#6 x 5/8"	ORB

- Material: Aluminum
- For material thickness of 13/16"
- Flush mortise mounting

3 7/8" pulls are polybagged with two screws.

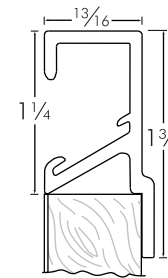

DP414

PART NUMBER	CC	OVERALL LENGTH	SCREWS	FINISH
DP414-A	1 7/8"	3 7/8"	#5 x 1/2"	A
DP414-B	1 7/8"	3 7/8"	#5 x 1/2"	B
DP414-BL	1 7/8"	3 7/8"	#5 x 1/2"	BL
DP414-BZ	1 7/8"	3 7/8"	#5 x 1/2"	BZ
DP414-ORB	1 7/8"	3 7/8"	#5 x 1/2"	ORB
DP414-L-A	no holes	6'	no screws	A
DP414-L-M	no holes	6'	no screws	M

- Material: Aluminum
- For material thickness of 13/16"
- Flush mortise mounting

3 7/8" pulls are polybagged with two screws.

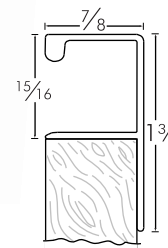

SEE PAGE 9 FOR FINISHES

Architectural Drawer and Door Pulls

DP417

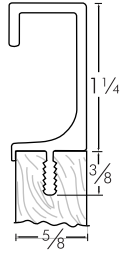

PART NUMBER	CC	OVERALL LENGTH	SCREWS	FINISH
DP417-L-A	no holes	6'	no screws	A

- For material thickness of $\frac{5}{8}$ "
- $\frac{1}{8}$ " saw kerf mounting
- Custom sizes available

DP418

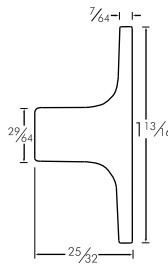

PART NUMBER	CC	OVERALL LENGTH	SCREWS	FINISH
DP418-A	2 1/2"	3 1/16"	8-32 x 1"	A
DP418-B	2 1/2"	3 1/16"	8-32 x 1"	B
DP418-BL	2 1/2"	3 1/16"	8-32 x 1"	BL
DP418-BZ	2 1/2"	3 1/16"	8-32 x 1"	BZ
DP418-ORB	2 1/2"	3 1/16"	8-32 x 1"	ORB

- For any material thickness
- Surface mounting
- Custom sizes available

3 1/16" pulls are polybagged with two screws.

DP419

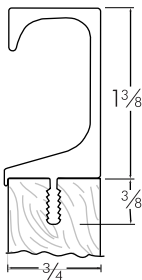

PART NUMBER	CC	OVERALL LENGTH	SCREWS	FINISH
DP419-L-A	no holes	6'	no screws	A

- For material thickness of $\frac{3}{4}$ "
- $\frac{1}{8}$ " saw kerf mounting
- Custom sizes available

SEE PAGE 9 FOR FINISHES

WP34

PART NUMBER	CC	OVERALL LENGTH	SCREWS	FINISH
WP34-A	2"	2 3/4"	8-32 x 1"	Aluminum
WP34-B	2"	2 3/4"	8-32 x 1"	Brass
WP34-BL	2"	2 3/4"	8-32 x 1"	Black
WP34-BZ	2"	2 3/4"	8-32 x 1"	Bronze
WP34-ORB	2"	2 3/4"	8-32 x 1"	Oil Rubbed Bronze

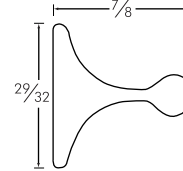

- For any material thickness
- Surface mounting
- Custom sizes available
- Material: Aluminum
- Polybagged with screws.

SEE PAGE 9 FOR FINISHES

DP341



PART NUMBER	CC	PROJECTION	OVERALL LENGTH	FINISH
DP341-DC	4"	27/32"	4 5/16"	Dull Chrome

- Material: Zinc
- Polybagged with screws.

DP430



PART NUMBER	CC	PROJECTION	OVERALL LENGTH	FINISH
DP430-13-SL	4"	1"	4 1/2"	Satin Lacquered

- Material: Aluminum
- Polybagged with screws.

DP433



PART NUMBER	CC	PROJECTION	OVERALL LENGTH	FINISH
DP433-4-SL	4"	7/8"	4 3/8"	Satin Lacquered
DP433-96-SL	96mm	7/8"	4 3/8"	Satin Lacquered

- Material: Aluminum
- Polybagged with screws.

Brass Drawer and Door Pulls



DP422

PART NUMBER FINISH

DP422-PB	Polished Brass
----------	----------------

- 1 1/4" W 1 1/2" H
- Individually polybagged
- Cast brass
- #4 x 1/2" screws



DP423

PART NUMBER FINISH

DP423-PB	Polished Brass
----------	----------------

- 1 1/2" W 1 3/4" H
- Individually polybagged
- Cast brass
- #5 x 1/2" screws



DP424

PART NUMBER FINISH

DP424-PB	Polished Brass
----------	----------------

- 1 1/2" diameter
- Individually polybagged
- Cast brass
- #4 x 1/2" screws



DP425

PART NUMBER FINISH

DP425-PB	Polished Brass
----------	----------------

- 2" center to center
- 2 1/4" W 1 3/16" H
- Cast brass
- 9/16" projection
- #3 x 5/8" screws

Sliding Door Pulls

GP-17

PART NUMBER	MATERIAL	COLOR
GP17-A	Plastic	Aluminum
GP17-B	Plastic	Brass
GP17-BL	Plastic	Black
GP17-BZ	Plastic	Dark Bronze
GP17-C	Plastic	Clear
GP17-WH	Plastic	White



- Stick-on pull.
- Has pressure sensitive adhesive backing
- 2 13/16" x 1 3/16" x 1/8"

GP-18

PART NUMBER	MATERIAL	COLOR
GP18-BZ	Plastic	Dark Bronze
GP18-C	Plastic	Clear



- Stick-on pull.
- Has pressure sensitive adhesive backing
- 2 1/2" x 1" x 5/32"

GP-15

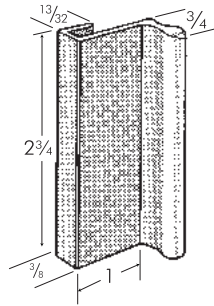

PART NUMBER	LENGTH	FOR DOOR THICKNESS	MATERIAL	FINISH
GP15-A	2 3/4"	1/4"	Aluminum	Satin Clear Anodized
GP15-B	2 3/4"	1/4"	Aluminum	Satin Brass Anodized
GP15-BL	2 3/4"	1/4"	Aluminum	Satin Black Anodized
GP15-ORB	2 3/4"	1/4"	Aluminum	Oil Rubbed Bronze Anodized
GP15-L-A	6'	1/4"	Aluminum	Satin Clear Anodized
GP15-L-M	6'	1/4"	Aluminum	Mill Aluminum

Press fits onto door using part number 2021 glazing vinyl or press fits onto taped edge of door. See page 53 for glazing vinyl 2021.

GP-19

PART NUMBER	PROJECTION	DIAMETER	MATERIAL	FINISH
GP19-A	1/2"	33/64"	Aluminum	Satin Clear Anodized
GP19-B	1/2"	33/64"	Aluminum	Satin Brass Anodized
GP19-BL	1/2"	33/64"	Aluminum	Satin Black Anodized

Ideal for mounting to sliding glass door shoe (part # 743). Packaged with one 6-32 X 3/4" screw, one 6-32 X 5/8" and one rubber bumper.



GP-20

PART NUMBER	PROJECTION	DIAMETER	MATERIAL	FINISH
GP20-A	3/4"	15/32"	Aluminum	Satin Clear Anodized
GP20-B	3/4"	15/32"	Aluminum	Satin Brass Anodized
GP20-BL	3/4"	15/32"	Aluminum	Satin Black Anodized

Ideal for mounting to sliding glass door shoe (part # 743). Packaged with one 6-32 X 3/4" screw, one 6-32 X 5/8" and one rubber bumper.



Wire Pulls



MC401-3

PART NUMBER MATERIAL

MC401-3-PC	Steel
MC401-3-PB	Steel
MC401-3-BRC	Steel
MC401-3-DC	Steel

CC = 3", OD = 5/16", P = 1 5/16"

MC401-3.5

PART NUMBER MATERIAL

MC401-3.5-PC	Steel
MC401-3.5-PB	Steel
MC401-3.5-BRC	Steel
MC401-3.5-DC	Steel

CC = 3.5", OD = 5/16", P = 1 5/16"

MC401-96

PART NUMBER MATERIAL

MC401-96-PC	Steel
MC401-96-PB	Steel
MC401-96-BRC	Steel
MC401-96-DC	Steel

CC = 96mm, OD = 5/16", P = 1 5/16"

MC401-4

PART NUMBER MATERIAL

MC401-4-PC	Steel
MC401-4-PB	Steel
MC401-4-BRC	Steel
MC401-4-DC	Steel

CC = 4", OD = 5/16", P = 1 5/16"

Wire Pulls

HANDLES & KNOBS

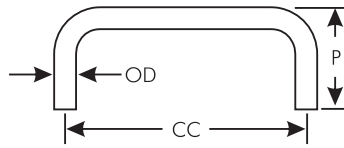

MC402-64

PART NUMBER MATERIAL

MC402-64-DB	Solid Brass
MC402-64-DC	Solid Brass
MC402-64-PB	Solid Brass
MC402-64-PC	Solid Brass

CC = 64mm, OD = 5/16", P = 1 5/16"

MC402-3

PART NUMBER MATERIAL

MC402-3-10B	Solid Brass
MC402-3-A	Aluminum
MC402-3-B	Aluminum
MC402-3-BL	Aluminum
MC402-3-BRC	Solid Brass
MC402-3-BZ	Aluminum
MC402-3-DB	Solid Brass
MC402-3-ORB	Solid Brass
MC402-3-ORB-AL	Aluminum
MC402-3-DC	Solid Brass
MC402-3-PB	Solid Brass
MC402-3-PBL	Aluminum
MC402-3-PC	Solid Brass
MC402-3-SS	Stainless Steel
MC402-3-WH	Aluminum

CC = 3", OD = 5/16", P = 1 5/16"

MC402-4

PART NUMBER MATERIAL

MC402-4-A	Aluminum
MC402-4-B	Aluminum
MC402-4-BL	Aluminum
MC402-4-BRC	Solid Brass
MC402-4-BZ	Aluminum
MC402-4-DB	Solid Brass
MC402-4-ORB	Solid Brass
MC402-4-ORB-AL	Aluminum
MC402-4-DC	Solid Brass
MC402-4-PB	Solid Brass
MC402-4-PBL	Aluminum
MC402-4-PC	Solid Brass
MC402-4-SS	Stainless Steel
MC402-4-WH	Aluminum

CC = 4", OD = 5/16", P = 1 5/16"

MC402-3.5

PART NUMBER MATERIAL

MC402-3.5-10B	Solid Brass
MC402-3.5-A	Aluminum
MC402-3.5-B	Aluminum
MC402-3.5-BL	Aluminum
MC402-3.5-BRC	Solid Brass
MC402-3.5-BZ	Aluminum
MC402-3.5-DB	Solid Brass
MC402-3.5-ORB	Solid Brass
MC402-3.5-ORB-AL	Aluminum
MC402-3.5-DC	Solid Brass
MC402-3.5-PB	Solid Brass
MC402-3.5-PBL	Aluminum
MC402-3.5-PC	Solid Brass
MC402-3.5-SS	Stainless Steel
MC402-3.5-WH	Aluminum

CC = 3.5", OD = 5/16", P = 1 5/16"

MC402-96

PART NUMBER MATERIAL

MC402-96-10B	Solid Brass
MC402-96-A	Aluminum
MC402-96-B	Aluminum
MC402-96-BL	Aluminum
MC402-96-BRC	Solid Brass
MC402-96-BZ	Aluminum
MC402-96-DB	Solid Brass
MC402-96-ORB	Solid Brass
MC402-96-ORB-AL	Aluminum
MC402-96-DC	Solid Brass
MC402-96-PB	Solid Brass
MC402-96-PBL	Aluminum
MC402-96-PC	Solid Brass
MC402-96-SS	Stainless Steel
MC402-96-WH	Aluminum

CC = 96mm, OD = 5/16", P = 1 5/16"

MC402-5

PART NUMBER MATERIAL

MC402-5-A	Aluminum
MC402-5-B	Aluminum
MC402-5-BL	Aluminum
MC402-5-BRC	Solid Brass
MC402-5-BZ	Aluminum
MC402-5-ORB-AL	Aluminum
MC402-5-PB	Solid Brass
MC402-5-PC	Solid Brass
MC402-5-SS	Stainless Steel

CC = 5", OD = 5/16", P = 1 13/32"

MC402-6

PART NUMBER MATERIAL

MC402-6-A	Aluminum
MC402-6-B	Aluminum
MC402-6-BL	Aluminum
MC402-6-BRC	Solid Brass
MC402-6-BZ	Aluminum
MC402-6-ORB-AL	Aluminum
MC402-6-PB	Solid Brass
MC402-6-PC	Solid Brass
MC402-6-SS	Stainless Steel

CC = 6", OD = 5/16", P = 1 13/32"

MC402-8

PART NUMBER MATERIAL

MC402-8-A	Aluminum
MC402-8-SS	Stainless Steel

CC = 8", OD = 5/16", P = 1 5/16"

Wire Pulls



MC400

PART NUMBER	CC	PROJECTION P	DIAMETER OD	MATERIAL	FINISH
MC400-SS	5"	2 13/16"	5/16"	304 Stainless Steel	Stainless Steel

- Surface mount.
- Polybagged with two 10-32 x 1 1/4" screws

MC405



PART NUMBER	CC	PROJECTION P	DIAMETER OD	MATERIAL	FINISH
MC405-3-SL	3"	1 5/16"	5/16"	Aluminum	Satin Laquered
MC405-3.5-SL	3.5"	1 5/16"	5/16"	Aluminum	Satin Laquered
MC405-4-SL	4"	1 5/16"	5/16"	Aluminum	Satin Laquered
MC405-96-SL	96mm	1 5/16"	5/16"	Aluminum	Satin Laquered

- Surface mount.
- Polybagged with two 8-32 x 1" screws

MC427



PART NUMBER	CC	PROJECTION P	DIAMETER OD	MATERIAL	FINISH
MC427-A	4"	1 7/8"	1/2"	Aluminum	Satin Clear Anodized

- Surface mount.
- Polybagged with two 10-32 x 1 1/4" screws

MC428



PART NUMBER	CC	PROJECTION P	DIAMETER OD	MATERIAL	FINISH
MC428-A	5"	3"	1/2"	Aluminum	Satin Clear Anodized

- Surface mount.
- Polybagged with two 10-32 x 1 1/4" screws

 Americans with Disabilities Act (**ADA**) compliant

PART NUMBER	PROJECTION	DIAMETER	COLOR
KP401-2-AL	1"	1 5/16"	Almond
KP401-2-BL	1"	1 5/16"	Black
KP401-2-G	1"	1 5/16"	Gray
KP401-2-PB	1"	1 5/16"	Polished Brass
KP401-2-PC	1"	1 5/16"	Polished Chrome
KP401-2-WH	1"	1 5/16"	White

KP401



Polybagged with #8 x 1 1/8" self tapping screw

3" CC

PART NUMBER	COLOR
MC302-2-AL	Almond
MC302-2-BL	Black
MC302-2-G	Gray
MC302-2-PB	Polished Brass
MC302-2-PC	Polished Chrome
MC302-2-WH	White

MC302



- 3" CC
- 1 1/4" Projection
- 25/64" Diameter

Polybagged with #8 x 1 1/8" self tapping screws

96mm CC

PART NUMBER	COLOR
MC303-2-AL	Almond
MC303-2-BL	Black
MC303-2-G	Gray
MC303-2-PB	Polished Brass
MC303-2-PC	Polished Chrome
MC303-2-WH	White

MC303



- 96mm CC
- 1 1/4" Projection
- 25/64" Diameter

Polybagged with #8 x 1 1/8" self tapping screws

4" CC

PART NUMBER	COLOR
MC304-2-AL	Almond
MC304-2-BL	Black
MC304-2-G	Gray
MC304-2-PB	Polished Brass
MC304-2-PC	Polished Chrome
MC304-2-WH	White

MC304



- 4" CC
- 1 3/8" Projection
- 25/64" Diameter

Polybagged with #8 x 1 1/8" self tapping screws



DP1710

PART NUMBER CC PROJECTION LENGTH MATERIAL FINISH

DP1710-AL	2 ⁷ / ₈ "	9 ¹ / ₁₆ "	3 ¹⁹ / ₃₂ "	Plastic	Almond
DP1710-BL	2 ⁷ / ₈ "	9 ¹ / ₁₆ "	3 ¹⁹ / ₃₂ "	Plastic	Black
DP1710-BR	2 ⁷ / ₈ "	9 ¹ / ₁₆ "	3 ¹⁹ / ₃₂ "	Plastic	Brown
DP1710-G	2 ⁷ / ₈ "	9 ¹ / ₁₆ "	3 ¹⁹ / ₃₂ "	Plastic	Gray
DP1710-W	2 ⁷ / ₈ "	9 ¹ / ₁₆ "	3 ¹⁹ / ₃₂ "	Plastic	White

- mounts into a 3¹/₈" x 1¹/₄" x 7¹/₁₆" hole



ZP402

96mm CC



PART NUMBER CC PROJECTION DIAMETER MATERIAL FINISH

ZP402-96-AL	96mm	1"	3 ³ / ₈ "	Zinc Alloy	Almond
ZP402-96-BL	96mm	1"	3 ³ / ₈ "	Zinc Alloy	Black
ZP402-96-BRC	96mm	1"	3 ³ / ₈ "	Zinc Alloy	Brushed Chrome
ZP402-96-OF	96mm	1"	3 ³ / ₈ "	Zinc Alloy	Off White
ZP402-96-PB	96mm	1"	3 ³ / ₈ "	Zinc Alloy	Polished Brass
ZP402-96-PC	96mm	1"	3 ³ / ₈ "	Zinc Alloy	Polished Chrome
ZP402-96-WH	96mm	1"	3 ³ / ₈ "	Zinc Alloy	White

- Surface mount.
- Polybagged with two 8-32 x 1 screws

DP485

PART NUMBER MATERIAL FINISH

DP485-PC	304 Stainless Steel	Polished Chrome
DP485-SS	304 Stainless Steel	Satin Stainless

Dimensions: 36mm (1.42 in) x 85mm (3.35 in)
Mounting hole: 30mm (1.18 in) x 67mm (2.64 in)

Pulls mount flush with the face of your drawer or door.
Side screw, pin mounted or glued.



DP4115

PART NUMBER MATERIAL FINISH

DP4115-PC	304 Stainless Steel	Polished Chrome
DP4115-SS	304 Stainless Steel	Satin Stainless

Dimensions: 42mm (1.65 in) x 115mm (4.53 in)
Mounting hole: 34mm (1.34 in) x 93mm (3.66 in)

Pulls mount flush with the face of your drawer or door. Side screw, pin mounted or glued.



Recessed Pulls

HANDLES & KNOBS

WP38

PART NUMBER	FOR DOOR THICKNESS	MATERIAL	FINISH
WP38-DC	1/4" to 1/2"	zinc	dull chrome

- Mortises into a 7/8" x 3 13/16" hole
- Polybagged with #8-32 screws

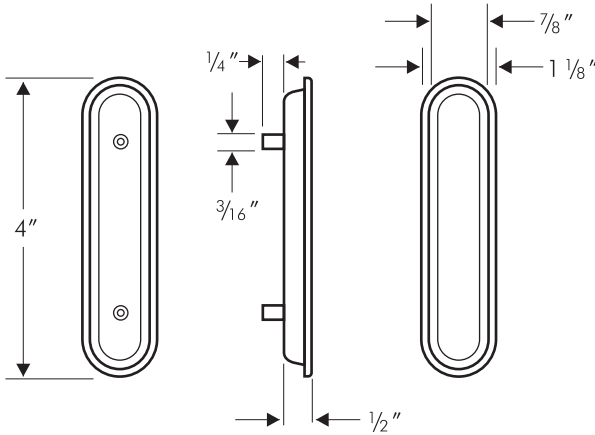

WP36

PART NUMBER	FOR DOOR THICKNESS	MATERIAL	FINISH
WP36-DB	1/8"	solid brass	dull brass

- Mortises into a 1 5/8" hole

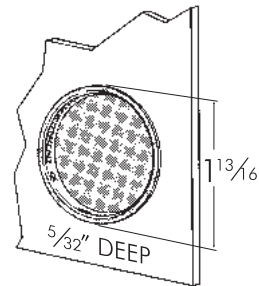

WP37

PART NUMBER	FOR DOOR THICKNESS	MATERIAL	FINISH
WP37-DB	1/4" to 1/2"	solid brass	dull brass
WP37-DC	1/4" to 1/2"	solid brass	dull chrome

- Mortises into a 1 5/8" hole

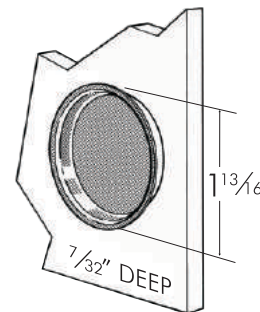

Surface Mount Wood Pulls

WP22



PART NUMBER	CC	PROJECTION	OVERALL LENGTH	WIDTH
WP22	96mm	1"	4 ³ / ₄ "	3 ³ / ₈ "

- Unfinished Oak
- Polybagged with two 8-32 x 1" screws.

WP26



PART NUMBER	CC	PROJECTION	OVERALL LENGTH	WIDTH
WP26	96mm	2 ⁷ / ₃₂ "	4 ⁹ / ₁₆ "	1 ²⁵ / ₃₂ "

- Surface mount
- Unfinished Oak
- Polybagged with two 8-32 x 1" screws

WP28



PART NUMBER	CC	PROJECTION	OVERALL LENGTH	WIDTH
WP28	96mm	1 ³ / ₁₆ "	4 ¹ / ₂ "	2 ³ / ₁₆ "

- Surface mount - no insert
- Unfinished Oak
- Polybagged with two 8-32 x 1" screws

WP29



PART NUMBER	CC	PROJECTION	OVERALL LENGTH	WIDTH
WP29	110mm	1 ¹ / ₈ "	5 ¹ / ₂ "	5 ⁵ / ₈ "

- Unfinished Oak
- Polybagged with two 8-32 x 1" screws

WP30



PART NUMBER	CC	PROJECTION	OVERALL LENGTH	WIDTH
WP30-3	3"	1 ¹ / ₈ "	3 ⁷ / ₁₆ "	1 ⁵ / ₃₂ "
WP30-3.5	3.5"	1 ¹ / ₈ "	4"	1 ⁵ / ₃₂ "
WP30-4	4"	1 ¹ / ₈ "	4 ¹ / ₂ "	1 ⁵ / ₃₂ "
WP30-96	96mm	1 ¹ / ₈ "	4 ¹ / ₄ "	1 ⁵ / ₃₂ "

- Unfinished Oak
- Polybagged with two 8-32 x 1" screws

HANDLES & KNOBS

PART NUMBER	CC	PROJECTION	OVERALL LENGTH	WIDTH
WP31	2"	$2\frac{9}{32}$ "	4"	$2\frac{7}{32}$ "

- Surface mount - no insert
- Unfinished Oak
- Polybagged with two 8-32 x 1" screws



PART NUMBER	CC	PROJECTION	OVERALL LENGTH	WIDTH
WP32	$3\frac{1}{2}$ "	$1\frac{1}{4}$ "	$4\frac{1}{8}$ "	$\frac{5}{8}$ "

- Unfinished Oak
- Polybagged with two 8-32 x 1" screws



Recessed Mount Wood Pulls

PART NUMBER	CC	PROJECTION	OVERALL LENGTH	WIDTH
WP23	NO HOLES	$\frac{7}{8}$ "	$4\frac{3}{32}$ "	$1\frac{1}{4}$ "

- Surface mount
- Unfinished Oak
- No screws

INSERT SIZE

LENGTH	HEIGHT	DEPTH
$3\frac{19}{32}$ "	$1\frac{3}{16}$ "	$\frac{5}{16}$ "



PART NUMBER	CC	PROJECTION	OVERALL LENGTH	WIDTH
WP24	NO HOLES	$2\frac{7}{32}$ "	$4\frac{1}{4}$ "	2"

- Surface mount
- Unfinished Oak
- No screws

INSERT SIZE

LENGTH	HEIGHT	DEPTH
$3\frac{3}{4}$ "	$1\frac{13}{16}$ "	$\frac{7}{16}$ "



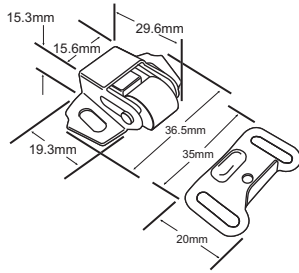

501

PART NUMBER FINISH

501	Zinc
-----	------

Roller catch. Steel case.

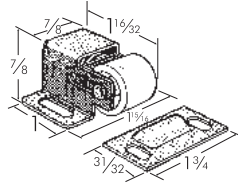

503

PART NUMBER FINISH

503	Zinc
-----	------

Roller catch. Steel case.

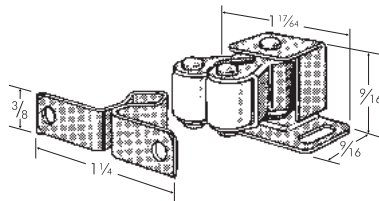

504

PART NUMBER FINISH

504-1	Zinc
-------	------

Roller catch. Steel case.

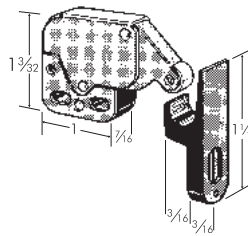

505

PART NUMBER COLOR

505-BP	Brass/Brown
505-NP	Nickel/White

Mini touch latch. Steel and plastic case. Plastic strike.

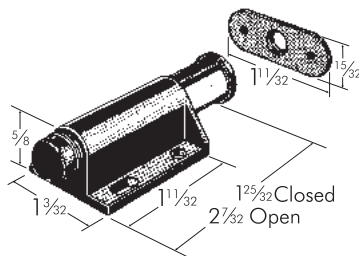

507

PART NUMBER COLOR

507-BL-PWS	Black
507-BR-PWS	Brown
507-WH-PWS	White

Single magnetic touch latch. Plastic case. Polybagged with strike plate and screws. Can be used with 509 or 516 glass door strike plates.

CATCHES AND TOUCH LATCHES

PART NUMBER **COLOR**

508-BL-PWS	Black
508-BR-PWS	Brown
508-WH-PWS	White

Double magnetic touch latch. Plastic case. Polybagged with strike plate and screws. Can be used with 509 or 516 glass door strike plates.

508

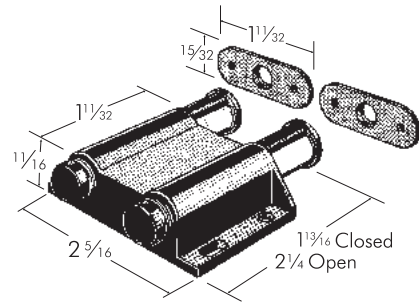

PART NUMBER **COLOR**

512	Black
-----	-------

Bore in magnetic touch latch. Press fits into 10mm hole. Plastic case. Bulk packaged. Can be used with 509 or 516 glass door strike plates.

512

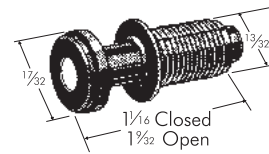

PART NUMBER **COLOR**

513	Black
-----	-------

Magnetic touch latch with mounting flange. Can be used with either wood or metal cabinets. Plastic case. Bulk packaged. Can be used with 509 or 516 glass door strike plates.

513

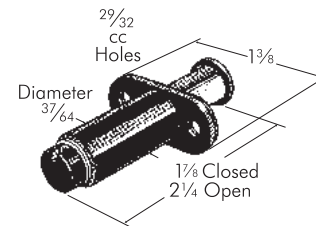

PART NUMBER **COLOR**

514-BL-PWS	Black
------------	-------

Single magnetic touch latch. Plastic case. Polybagged with small strike plate and screws. Can be used with 509 or 516 glass door strike plates.

514

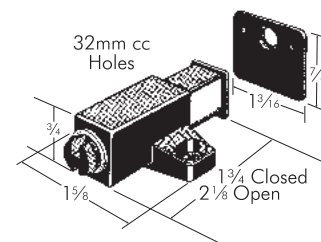

PART NUMBER **COLOR**

515-BL-PWS	Black
------------	-------

Double magnetic touch latch. Plastic case. Polybagged with small strike plate and screws. Can be used with 509 or 516 glass door strike plates.

515

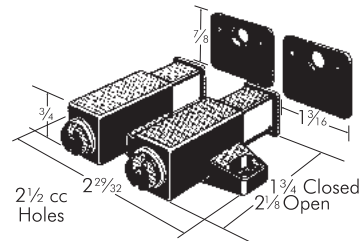

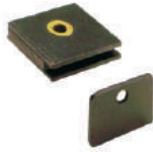
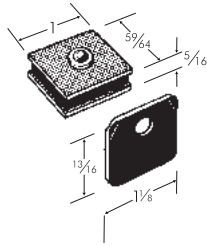

541

PART NUMBER	FINISH
541	Black

Magnetic catch for single cabinet doors. Steel case with black zinc plating. Lifetime magnet. Please see price list for packaging options.

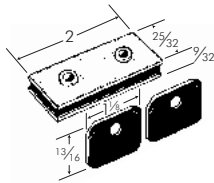

542

PART NUMBER	FINISH
542	Black

Magnetic catch for double cabinet doors or larger single cabinet doors. Steel case with black zinc plating. Lifetime magnet.

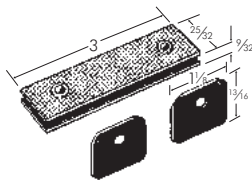

543

PART NUMBER	FINISH
543	Black

Magnetic catch for heavier double doors or extra large single cabinet doors. Steel case with black zinc plating. Lifetime magnet.

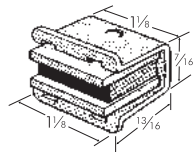

555

PART NUMBER	FINISH
555	Aluminum

Snap-in magnetic catch for metal cabinet doors. Aluminum case is self-aligning to strike plate. Snaps into a 1/2" x 1 3/16" opening in 18/20 gauge metal. Lifetime magnets.

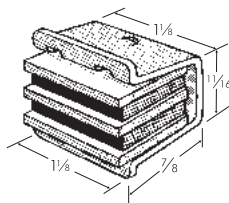

558

PART NUMBER	GAUGE
558	18/20
558-15	14/16

Snap-in magnetic catch for heavier metal cabinet doors. Aluminum case is self-aligning to strike plate. Snaps into a 3/4" x 1 3/16" opening in 14/16 gauge or 18/20 gauge metal (please specify). Lifetime magnets.

CATCHES AND TOUCH LATCHES

PART NUMBER	FINISH
590	Aluminum

Magnetic catch for cabinet doors. Aluminum case is self aligning to strike plate. Lifetime magnet.

590

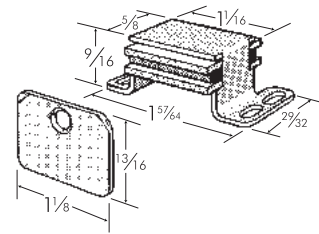

PART NUMBER	FINISH
591	Aluminum

Magnetic catch for cabinet doors. Aluminum case is self aligning to strike plate. Lifetime magnet.

591

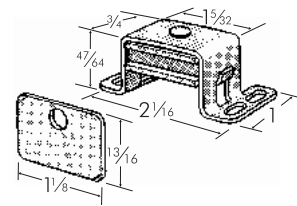
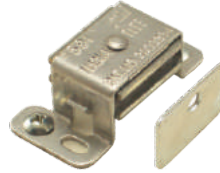

PART NUMBER	FINISH
592-P	Aluminum
592-ORB	Oil Rub Bronze

Heavy duty magnetic catch for larger cabinet doors. Ideal for institutional and commercial cabinets. Aluminum case is self aligning to strike plate. Lifetime magnet.

592

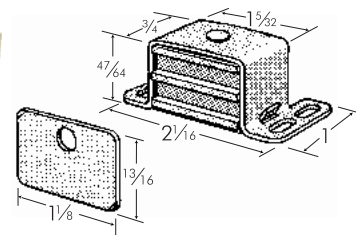
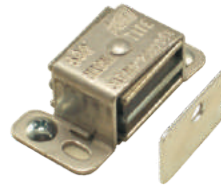

PART NUMBER	FINISH
593-SB	Satin Brass
593-DC	Dull Chrome
593-PB	Polished Brass

Extra heavy duty door retainer for heavy doors. Solid brass case is self-aligning to strike plate. Lifetime magnet.

593

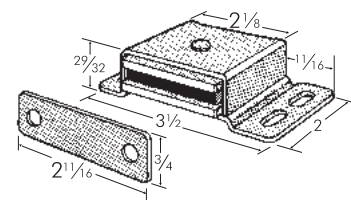

PART NUMBER	FINISH
600-A	Aluminum

Magnetic catch press fits into 5/8" bore. Aluminum case is self-aligning to strike plate. Lifetime magnet.

600

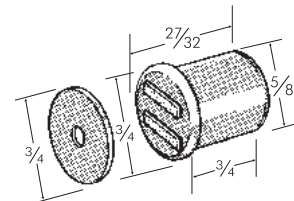

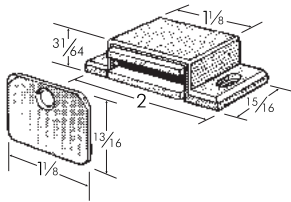

1000

PART NUMBER	COLOR
1000-AL	Almond
1000-G	Gray
1000-T	Tan
1000-WH	White

Magnetic catch for cabinet doors. Plastic case is self-aligning to strike plate. Lifetime magnet.

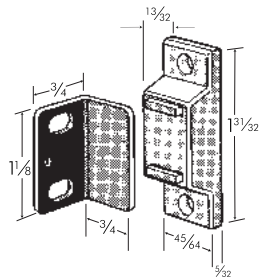

1001

PART NUMBER	COLOR
1001-T	Tan

Magnetic catch for cabinet doors. Plastic case is self-aligning to strike plate. Lifetime magnet.

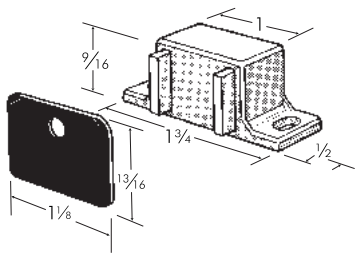

1003

PART NUMBER	COLOR
1003-T	Tan

Magnetic catch for cabinet doors. Plastic case is self-aligning to strike plate. Lifetime magnet.

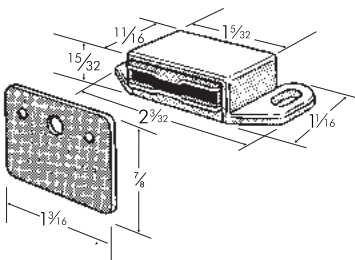

1004

PART NUMBER	COLOR
1004-T	Tan

Magnetic catch for cabinet doors. Plastic case is self-aligning to strike plate. Lifetime magnet.

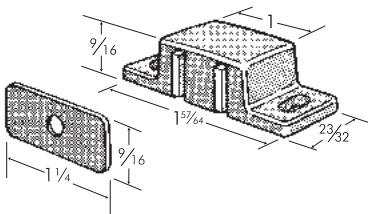

1006

PART NUMBER	COLOR
1006-BR	Brown

Magnetic catch for cabinet doors. Plastic case is self-aligning to strike plate. Lifetime magnet.

CATCHES AND TOUCH LATCHES

1009

PART NUMBER	COLOR
1009-BR	Brown
1009-T	Tan

Magnetic catch for cabinet doors. Plastic case is self-aligning to strike plate. Lifetime magnet.

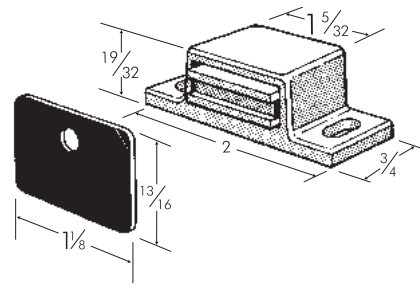

1010

PART NUMBER	COLOR
1010-BR	Brown
1010-WH	White

Magnetic catch for cabinet doors. Plastic case is self-aligning to strike plate. Lifetime magnet.

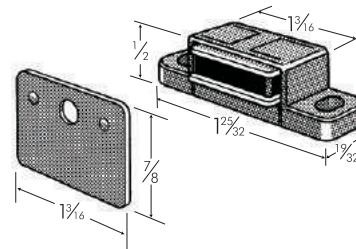

1014

PART NUMBER	COLOR
1014-BR	Brown
1014-WH	White

Magnetic catch for cabinet doors. 32mm hole centers. Plastic case is self-aligning to strike plate. Lifetime magnet.

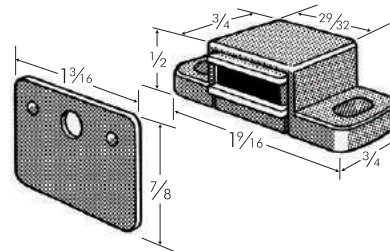

1015

PART NUMBER	COLOR
1015-BR	Brown
1015-WH	White

Magnetic catch for cabinet doors. 64mm hole centers. Plastic case is self-aligning to strike plate. Lifetime magnet.

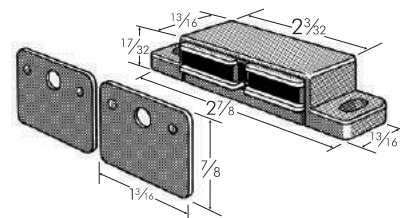

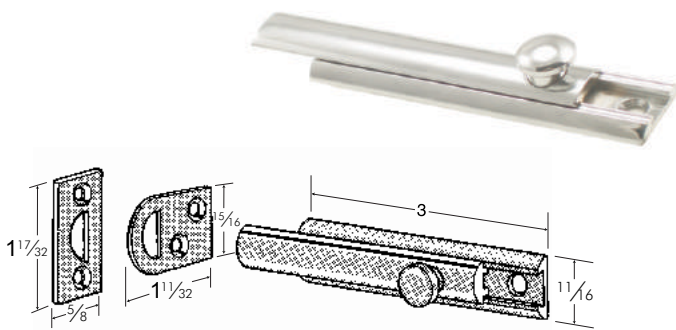

910

PART NUMBER	FINISH
910-PC	Polished Chrome

Slide bolt. Solid brass material. Polybagged with two strike plates.

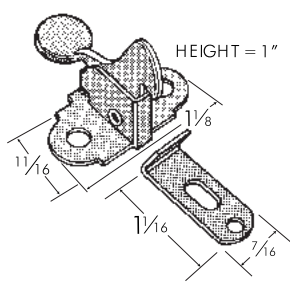

1016

PART NUMBER	FINISH
1016-B	Bright Brass
1016-N	Bright Nickel

Elbow catch. Strike plate has slot to provide adjustment. Stamped steel. Polybagged with screws.

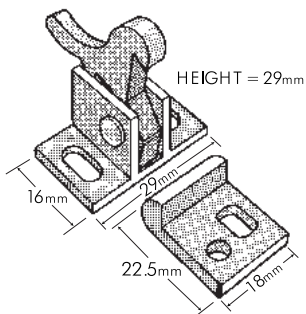

1018

PART NUMBER	FINISH
1018-B	Bright Brass
1018-N	Bright Nickel
1018-N-Bulk	Bright Nickel

Heavy duty elbow catch. Both catch and strike plate have slots to provide adjustment. Strike plate has extra screw hole to prevent spinning on plastic laminate. Ideal for institutional and commercial cabinets. Solid brass. Polybagged with screws.

CATCHES AND TOUCH LATCHES

1011

PART NUMBER	FINISH
1011-DB	Dull Brass
1011-DC	Dull Chrome

Adjustable tension ball catch.
Turn screws to adjust tension.
Solid brass case. Polybagged
with screws.

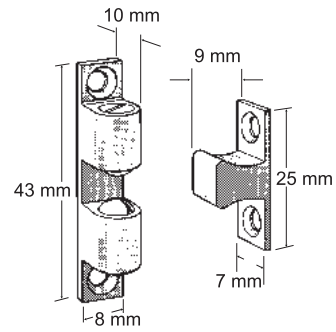

1012

PART NUMBER	FINISH
1012-DB	Dull Brass
1012-DC	Dull Chrome

Adjustable tension ball catch.
Turn screws to adjust tension.
Solid brass case. Polybagged
with screws.

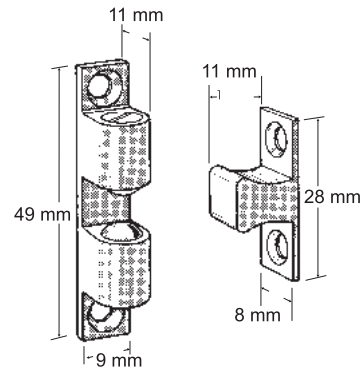

1013

PART NUMBER	FINISH
1013-DB	Dull Brass
1013-DC	Dull Chrome

Adjustable tension ball catch.
Turn screws to adjust tension.
Solid brass case. Polybagged
with screws.

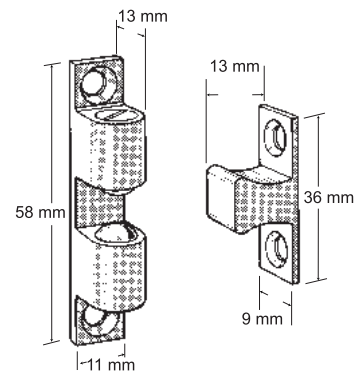

1017

PART NUMBER	FINISH
1017-DB	Dull Brass
1017-DC	Dull Chrome

Adjustable tension ball catch. Turn
screws to adjust tension. Solid brass
case. Polybagged with screws.

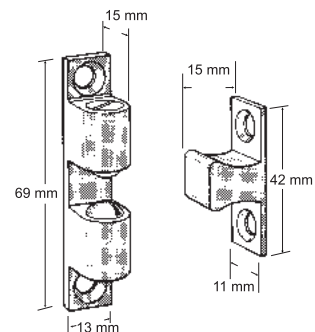
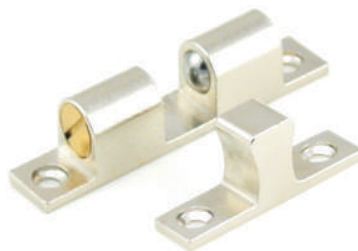

Round 1-1/16" Diameter Rod



870
STAINLESS
STEEL

PART NUMBER	LENGTH	MATERIAL	FINISH
870-4	4'	Stainless Steel	Brushed
870-5	5'	Stainless Steel	Brushed
870-6	6'	Stainless Steel	Brushed
870-8	8'	Stainless Steel	Brushed
870-10	10'	Stainless Steel	Brushed
870-12	12'	Stainless Steel	Brushed

- Bright Solid Seamless Stainless Steel
- Outside Diameter: 1 1/16"
- Wall thickness: 14 gauge



890
STEEL

PART NUMBER	LENGTH	MATERIAL	FINISH
890-4	4'	Steel	Polished Chrome
890-5	5'	Steel	Polished Chrome
890-6	6'	Steel	Polished Chrome
890-8	8'	Steel	Polished Chrome
890-10	10'	Steel	Polished Chrome
890-12	12'	Steel	Polished Chrome

- Outside Diameter: 1 1/16"
- Wall thickness: 14 gauge



890
ALUMINUM

PART NUMBER	LENGTH	MATERIAL	FINISH
890-8-DC	8'	Aluminum	Dull Chrome
890-8-ORB	8'	Aluminum	Oil Rubbed Bronze

- Outside Diameter: 1 1/16"
- Wall thickness: 14 gauge



891

PART NUMBER	MATERIAL	FINISH
891-PC	Stainless Steel	Polished Chrome
891-ORB	Stainless Steel	Oil Rubbed Bronze

- End Cap for 1 1/16" tubing



856

PART NUMBER	MATERIAL	FINISH
856	Stainless Steel	Brushed

- Closed flange for 1" and 1 1/16" tubing
- Includes stainless steel cover to conceal mounting screws.

TUBING AND CLOSET HARDWARE

PART NUMBER	MATERIAL	FINISH
855-SS	Stainless Steel	Brushed Stainless
855-PC	Aluminum	Polished Chrome
855-ORB	Aluminum	Oil Rubbed Bronze
855-DC	Aluminum	Dull Chrome

855



- Closed flange for 1" and 1 1/16" tubing
- Screws on to back plate and mounts invisibly.
- Screws on to back plate and mounts invisibly.
- polybagged with screws

PART NUMBER	MATERIAL	FINISH
860-PC	Zinc	Polished Chrome
860-SS	Stainless Steel	Polished Stainless
860-ORB	Zinc	Oil Rubbed Bronze

860



- Closed flange for 1" and 1 1/16" tubing
- polybagged with screws

PART NUMBER	MATERIAL	FINISH
850-PC	Zinc	Polished Chrome
850-SS	Stainless Steel	Polished Stainless
850-ORB	Zinc	Oil Rubbed Bronze

850



- Open flange for 1" and 1 1/16" tubing.
- polybagged with screws

PART NUMBER	MATERIAL	FINISH
852-PC	Zinc	Polished Chrome
852-ORB	Zinc	Oil Rubbed Bronze

852



- Open flange for 1" and 1 1/16" tubing
- 32mm closet system flange with 5mm pins
- polybagged with screws

PART NUMBER	MATERIAL	FINISH
853-PC	Zinc	Polished Chrome
853-ORB	Zinc	Oil Rubbed Bronze
853-DC	Zinc	Dull Chrome
853-SS	Stainless Steel	Brushed Stainless

853



- Center support for 1" and 1 1/16" tubing.
- polybagged with screws

Round 1-5/16" Diameter Rod



895
STEEL

PART NUMBER	LENGTH	MATERIAL	FINISH
895-6	6'	Steel	Polished Chrome
895-8	8'	Steel	Polished Chrome
895-10	10'	Steel	Polished Chrome
895-12	12'	Steel	Polished Chrome

- Polished Chrome Plated Steel
- Outside Diameter: 1 5/16"
- Wall thickness: 14 gauge



895
ALUMINUM

PART NUMBER	LENGTH	MATERIAL	FINISH
895-8-DC	8'	Aluminum	Dull Chrome
895-8-ORB	8'	Aluminum	Oil Rubbed Bronze
895-8-SB	8'	Aluminum	Satin Brass
895-8-SN	8'	Aluminum	Satin Nickel
895-8-BL	8'	Aluminum	Matte Black

- Outside Diameter: 1 5/16"
- Wall thickness: 14 gauge



851

PART NUMBER	MATERIAL	FINISH
851-PC	Zinc	Polished Chrome
851-ORB	Zinc	Oil Rubbed Bronze
851-SN	Zinc	Satin Nickel

- Open flange for 1 1/4" and 1 5/16" tubing
- polybagged with screws



861

PART NUMBER	MATERIAL	FINISH
861-PC	Zinc	Polished Chrome
861-ORB	Zinc	Oil Rubbed Bronze
861-SN	Zinc	Satin Nickel

- Closed flange for 1 1/4" and 1 5/16" tubing.
- polybagged with screws



857

PART NUMBER	MATERIAL	FINISH
857-PC	Aluminum	Polished Chrome
857-ORB	Aluminum	Oil Rubbed Bronze
857-DC	Aluminum	Dull Chrome
857-SN	Aluminum	Satin Nickel

- Closed flange for 1 1/4" and 1 5/16" tubing.
- Screws on to back plate and mounts invisibly.
- polybagged with screws



896

PART NUMBER	MATERIAL	FINISH
896-PC	Stainless Steel	Polished Chrome
896-ORB	Stainless Steel	Oil Rubbed Bronze

- End Cap for 1 5/16" tubing

TUBING AND CLOSET HARDWARE

PART NUMBER	MATERIAL	FINISH
864-PC	Zinc	Polished Chrome
864-ORB	Zinc	Oil Rubbed Bronze
864-SN	Zinc	Satin Nickel
864-BL	Zinc	Matte Black
864-SB	Zinc	Satin Brass
864-DC	Zinc	Dull Chrome

864



- Open flange for 1¼" and 1 5/16" tubing.
- Polybagged with screws

PART NUMBER	MATERIAL	FINISH
865-PC	Zinc	Polished Chrome
865-ORB	Zinc	Oil Rubbed Bronze
865-SN	Zinc	Satin Nickel
865-BL	Zinc	Matte Black
865-SB	Zinc	Satin Brass
865-DC	Zinc	Dull Chrome

865



- Closed flange for 1¼" and 1 5/16" tubing.
- Polybagged with screws

PART NUMBER	MATERIAL	FINISH
863-PC	Zinc	Polished Chrome
863-ORB	Zinc	Oil Rubbed Bronze
863-SN	Zinc	Satin Nickel
863-DC	Zinc	Dull Chrome

863



- Center support for 1 5/16" tubing.
- Polybagged with screws.

PART NUMBER	MATERIAL	FINISH
858-PC	Steel	Polished Chrome
858-ORB	Steel	Oil Rubbed Bronze
858-SS	Stainless Steel	Stainless Steel
858-WH	Steel	White

858



- Heavy Duty
- Shelf and Rod Bracket for 1" to 1 ½" tubing.
- Polybagged with screws.

PART NUMBER	MATERIAL	FINISH
859-PC	Steel	Polished Chrome
859-SN	Steel	Satin Nickel

859



- Heavy duty shelf support
- Polybagged with screws.
- Extra heavy duty

Oval Rod



**830
STEEL**

PART NUMBER LENGTH

830-8-PC	8'
830-12-PC	12'

- 15mm x 30mm
- Polished Chrome Finish
- 8' and 12' lengths
- Wall thickness: 1 mm



**830
ALUMINUM**

PART NUMBER FINISH

830-8-DC	Dull Chrome
830-8-ORB	Oil Rubbed Bronze
830-8-BL	Matte Black
830-8-SN	Satin Nickel
830-8-SB	Satin Brass

- 15mm x 30mm
- 8 feet long
- Anodized Aluminum
- Wall thickness: 1 mm



830-90

PART NUMBER DIMENSIONS FINISH

830-90-PC	30" x 30"	Polished Chrome
830-90-ORB	30" x 30"	Oil Rubbed Bronze
830-90-PC-SM	12" x 12"	Polished Chrome
830-90-ORB-SM	12" x 12"	Oil Rubbed Bronze

- Standard 15mm x 30mm Oval tubing
- 90° angle
- Wall thickness: 1 mm

830-90

PART NUMBER DIMENSIONS FINISH

KIT830-90-PC	30" x 30"	Polished Chrome
KIT830-90-ORB	30" x 30"	Oil Rubbed Bronze
KIT830-90-PC-SM	12" x 12"	Polished Chrome
KIT830-90-ORB-SM	12" x 12"	Oil Rubbed Bronze

- Kit includes 90° angle rod, two 844 center supports and two 845 flanges.
- Standard 15mm x 30mm Oval tubing
- 90° angle
- Wall thickness: 1 mm



TUBING AND CLOSET HARDWARE

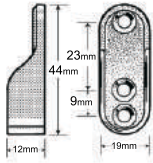

840

PART NUMBER	MATERIAL	FINISH
840-PC	Zinc	Polished Chrome
840-ORB	Zinc	Oil Rubbed Bronze
840-BL	Zinc	Matte Black
840-SN	Zinc	Satin Nickel
840-DC	Zinc	Dull Chrome
840-SB	Zinc	Satin Brass

- Mounting flange for 15mm x 30mm oval closet rod
- No mounting pins.
- Polybagged with screws

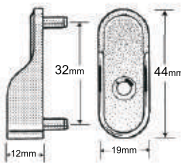

841

PART NUMBER	MATERIAL	FINISH
841-PC	Zinc	Polished Chrome
841-ORB	Zinc	Oil Rubbed Bronze
841-BL	Zinc	Matte Black
841-SN	Zinc	Satin Nickel
841-DC	Zinc	Dull Chrome
841-SB	Zinc	Satin Brass

- Mounting flange for 15mm x 30mm oval closet rod
- 32mm c-c spaced mounting pins on back
- Polybagged with screws



843

PART NUMBER	MATERIAL	FINISH
843	Zinc	Polished Chrome

- For oval tubing
- Mounting flange for 15mm x 30mm oval closet rod
- Two 32mm c-c spaced mounting pins on back
- Polybagged with screws

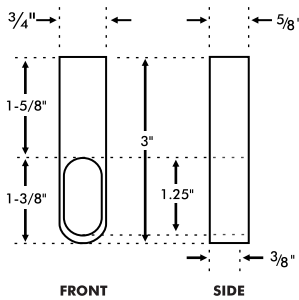

844

PART NUMBER	MATERIAL	FINISH
844-PC	Zinc	Polished Chrome
844-ORB	Zinc	Oil Rubbed Bronze

- Oval Center Support
- 15mm x 30mm opening
- Polybagged with screw

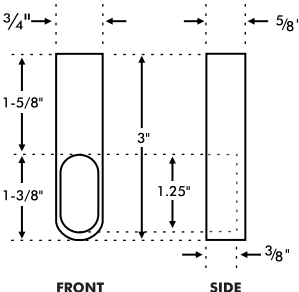

845

PART NUMBER	MATERIAL	FINISH
845-PC	Zinc	Polished Chrome
845-ORB	Zinc	Oil Rubbed Bronze

- Oval Flange
- 15mm x 30mm opening
- polybagged with screw

Oval Rod



831

PART NUMBER	MATERIAL	FINISH
831-PC	Stainless Steel	Polished Chrome
831-ORB	Stainless Steel	Oil Rubbed Bronze

- End Cap for Oval tubing



847

PART NUMBER	MATERIAL	FINISH
847-PC	Zamack	Polished Chrome
847-ORB	Zamack	Oil Rubbed Bronze
847-BL	Zamack	Black
847-DC	Zamack	Dull Chrome

- Oval Center Support/Flange
- 15mm x 30mm opening
- Plated Zamack
- Polybagged with screws

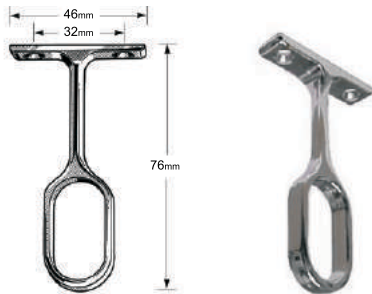

842

PART NUMBER	MATERIAL	FINISH
842-PC	Zinc	Polished Chrome
842-ORB	Zinc	Oil Rubbed Bronze
842-SN	Zinc	Satin Nickel

- Center support for oval tubing
- 32mm hole centers
- Polybagged with screws



848

PART NUMBER	MATERIAL	FINISH
848-PC	Steel	Polished Chrome
848-ORB	Steel	Oil Rubbed Bronze

- Heavy Duty
- Shelf/Rod Bracket for Oval 15 x 30 mm Rod
- Polybagged with screws

TUBING AND CLOSET HARDWARE



WL

PART NUMBER	SPAN
WL-800	24" - 33"
WL-1000	33" - 46"

- 37lb weight capacity
- Mounts to side panels or walls
- Polished Chrome Plated steel and ABS construction.
- Comes with standard 35" pull arm



WL-ARM

PART NUMBER	FINISH
WL-ARM	Satin Aluminum

- Extra long 49" lift arm
- Aluminum and ABS
- Works with WL-800, WL-1000



TIE-1-A

PART NUMBER	FINISH
TIE-1-A	Satin Aluminum

- Sliding tie rack mount left or right
- Holds 33 ties
- Aluminum and ABS
- 3 1/4" x 2 1/2" x 19"



VR100

PART NUMBER	FINISH
VR100-PC	Polished Chrome
VR100-ORB	Oil Rubbed Bronze
VR100-SN	Satin Nickel

- Inset Valet Rod
- Extends 4" from surface
- Polished Chrome plated steel body with end ball in 3 finishes.

CH101



PART NUMBER	BASE LENGTH	BASE WIDTH	PROJECTION	PACKAGING	MATERIAL	FINISH
CH101-ZC	1 7/8"	3/4"	2"	Bulk packed, no screws	Zamack	Polished Chrome
CH101-ZB	1 7/8"	3/4"	2"	Bulk packed, no screws.	Zamack	Polished Brass
CH101-ZC-2	1 7/8"	3/4"	2"	Polybagged with screws	Zamack	Polished Chrome
CH101-ZB-2	1 7/8"	3/4"	2"	Polybagged with screws	Zamack	Polished Brass
CH101-ZMN-2	1 7/8"	3/4"	2"	Polybagged with screws	Zamack	Matt Nickel
CH101-ZBN-2	1 7/8"	3/4"	2"	Polybagged with screws	Zamack	Brushed Nickel
CH101-ZAB-2	1 7/8"	3/4"	2"	Polybagged with screws	Zamack	Antique Brass

CH105



PART NUMBER	BASE LENGTH	BASE WIDTH	PROJECTION	PACKAGING	MATERIAL	FINISH
CH105-ZC	1 11/16"	1 1/8"	2 15/16"	Bulk packed, no screws	Zamack	Polished Chrome
CH105-ZB	1 11/16"	1 1/8"	2 15/16"	Bulk packed, no screws	Zamack	Polished Brass
CH105-ZC-2	1 11/16"	1 1/8"	2 15/16"	Polybagged with screws	Zamack	Polished Chrome
CH105-ZB-2	1 11/16"	1 1/8"	2 15/16"	Polybagged with screws	Zamack	Polished Brass
CH105-ZMN-2	1 11/16"	1 1/8"	2 15/16"	Polybagged with screws	Zamack	Matt Nickel
CH105-ZBN-2	1 11/16"	1 1/8"	2 15/16"	Polybagged with screws	Zamack	Brushed Nickel
CH105-ZAB-2	1 11/16"	1 1/8"	2 15/16"	Polybagged with screws	Zamack	Antique Brass

CH201



PART NUMBER	BASE LENGTH	BASE WIDTH	PROJECTION	PACKAGING	MATERIAL	FINISH
CH201-ZC	1 1/4"	1 1/8"	1 1/4"	Bulk packed, no screws	Zamack	Polished Chrome
CH201-ZB	1 1/4"	1 1/8"	1 1/4"	Bulk packed, no screws	Zamack	Polished Brass
CH201-ZC-2	1 1/4"	1 1/8"	1 1/4"	Polybagged with screws	Zamack	Polished Chrome
CH201-ZB-2	1 1/4"	1 1/8"	1 1/4"	Polybagged with screws	Zamack	Polished Brass
CH201-ZMN-2	1 1/4"	1 1/8"	1 1/4"	Polybagged with screws	Zamack	Matt Nickel
CH201-ZBN-2	1 1/4"	1 1/8"	1 1/4"	Polybagged with screws	Zamack	Brushed Nickel
CH201-ZAB-2	1 1/4"	1 1/8"	1 1/4"	Polybagged with screws	Zamack	Antique Brass

CH202



PART NUMBER	BASE LENGTH	BASE WIDTH	PROJECTION	PACKAGING	MATERIAL	FINISH
CH202-ZC	1 3/4"	1"	1 1/8"	Bulk packed, no screws	Zamack	Polished Chrome
CH202-ZB	1 3/4"	1"	1 1/8"	Bulk packed, no screws	Zamack	Polished Brass
CH202-ZC-2	1 3/4"	1"	1 1/8"	Polybagged with screws	Zamack	Polished Chrome
CH202-ZB-2	1 3/4"	1"	1 1/8"	Polybagged with screws	Zamack	Polished Brass
CH202-ZMN-2	1 3/4"	1"	1 1/8"	Polybagged with screws	Zamack	Matt Nickel
CH202-ZBN-2	1 3/4"	1"	1 1/8"	Polybagged with screws	Zamack	Brushed Nickel
CH202-ZAB-2	1 3/4"	1"	1 1/8"	Polybagged with screws	Zamack	Antique Brass
CH202-ORB	1 3/4"	1"	1 1/8"	Polybagged with screws	Zamack	Oil Rubbed Bronze

CH301



PART NUMBER	BASE LENGTH	BASE WIDTH	PROJECTION	PACKAGING	MATERIAL	FINISH
CH301-ZC	1 3/8"	3/4"	2 3/16"	Bulk packed, no screws	Zamack	Polished Chrome
CH301-ZB	1 3/8"	3/4"	2 3/16"	Bulk packed, no screws.	Zamack	Polished Brass
CH301-ZC-2	1 3/8"	3/4"	2 3/16"	Polybagged with screws	Zamack	Polished Chrome
CH301-ZB-2	1 3/8"	3/4"	2 3/16"	Polybagged with screws	Zamack	Polished Brass
CH301-ZMN-2	1 3/8"	3/4"	2 3/16"	Polybagged with screws	Zamack	Matt Nickel
CH301-ZBN-2	1 3/8"	3/4"	2 3/16"	Polybagged with screws	Zamack	Brushed Nickel
CH301-ZAB-2	1 3/8"	3/4"	2 3/16"	Polybagged with screws	Zamack	Antique Brass

COAT AND HAT HOOKS

CH102

PART NUMBER	BASE LENGTH	BASE WIDTH	PROJECTION	PACKAGING	MATERIAL	FINISH
CH102-ORB	1 7/8"	7/8"	1 1/2"	Polybagged with screws	Zamack	Oil Rubbed Bronze



CH203

PART NUMBER	BASE LENGTH	BASE WIDTH	PROJECTION	PACKAGING	MATERIAL	FINISH
CH203-ORB	1 1/2"	3/4"	1 1/2"	Polybagged with screws	Zamack	Oil Rubbed Bronze



CH204

PART NUMBER	BASE LENGTH	BASE WIDTH	PROJECTION	PACKAGING	MATERIAL	FINISH
CH204-ORB	2 3/8"	1 3/8"	1 13/16"	Polybagged with screws	Zamack	Oil Rubbed Bronze



CH800

PART NUMBER	PROJECTION	HOLES	MATERIAL	FINISH
CH800-3-PC	7"	3	Steel	Polished Chrome
CH800-3-ORB	7"	3	Steel	Oil Rubbed Bronze
CH800-6-PC	11"	6	Steel	Polished Chrome
CH800-6-ORB	11"	6	Steel	Oil Rubbed Bronze
CH800-10-PC	17"	10	Steel	Polished Chrome
CH800-10-ORB	17"	10	Steel	Oil Rubbed Bronze

- Polished Chrome or Oil Rubbed Bronze finishes.
- Adjusts to 4 different angle positions.
- Polybagged with screws.



CH600

PART NUMBER	PROJECTION	LENGTH	MATERIAL	FINISH
CH600-PC	1 1/2"	11"	Steel	Polished Chrome
CH600-ORB	1 1/2"	11"	Steel	Oil Rubbed Bronze

- Polished Chrome or Oil Rubbed Bronze.
- Polybagged with screws.



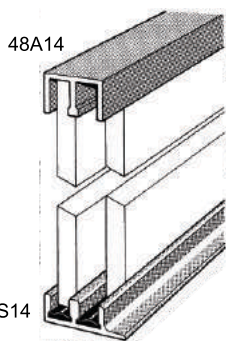

38AS14

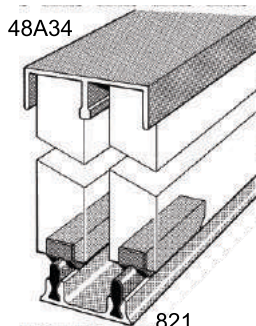

821

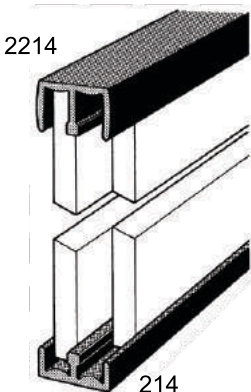

2214

214

Assembly #1

PART NUMBER	FOR DOOR THICKNESS	DOOR TYPE	LENGTH	MATERIAL	FINISH
1-A-3	1/4"	wood/glass	3'	Aluminum	Clear Anodized
1-A-4	1/4"	wood/glass	4'	Aluminum	Clear Anodized
1-A-5	1/4"	wood/glass	5'	Aluminum	Clear Anodized
1-A-6	1/4"	wood/glass	6'	Aluminum	Clear Anodized

Assembly #1 - Extruded aluminum sliding door track and guide system for heavier 1/4" by-passing doors. Bottom track has machined, hardened fibre inserts. Installation screws included.

Assembly #2

PART NUMBER	FOR DOOR THICKNESS	DOOR TYPE	LENGTH	MATERIAL	FINISH
2-A-3	3/4"	wood	3'	Aluminum	Clear Anodized
2-A-4	3/4"	wood	4'	Aluminum	Clear Anodized
2-A-5	3/4"	wood	5'	Aluminum	Clear Anodized
2-A-6	3/4"	wood	6'	Aluminum	Clear Anodized

Assembly #2 - Extruded aluminum sliding door track and guide system for heavier 3/4" by-passing doors. Bottom track has machined, hardened fibre inserts. Four fibre glides (#1801) recess into bottom of door and glide easily on track. Installation screws included.

Assembly #3

PART NUMBER	FOR DOOR THICKNESS	DOOR TYPE	LENGTH	MATERIAL	FINISH
3-BL-3	1/4"	wood/glass	3'	Plastic	Black
3-BL-4	1/4"	wood/glass	4'	Plastic	Black
3-BL-5	1/4"	wood/glass	5'	Plastic	Black
3-BL-6	1/4"	wood/glass	6'	Pplastic	Black
3-BR-3	1/4"	wood/glass	3'	Plastic	Brown
3-BR-4	1/4"	wood/glass	4'	Plastic	Brown
3-BR-5	1/4"	wood/glass	5'	Plastic	Brown
3-BR-6	1/4"	wood/glass	6'	Plastic	Brown
3-G-3	1/4"	wood/glass	3'	Plastic	Gray
3-G-4	1/4"	wood/glass	4'	Plastic	Gray
3-G-5	1/4"	wood/glass	5'	Plastic	Gray
3-G-6	1/4"	wood/glass	6'	Plastic	Gray
3-T-3	1/4"	wood/glass	3'	Plastic	Tan
3-T-4	1/4"	wood/glass	4'	Plastic	Tan
3-T-5	1/4"	wood/glass	5'	Plastic	Tan
3-T-6	1/4"	wood/glass	6'	Plastic	Tan
3-WH-3	1/4"	wood/glass	3'	Plastic	White
3-WH-4	1/4"	wood/glass	4'	Plastic	White
3-WH-5	1/4"	wood/glass	5'	Plastic	White
3-WH-6	1/4"	wood/glass	6'	Plastic	White

Assembly #3 - High impact, extruded polystyrene track and guide system for 1/4" by-passing doors. Recommended for small and/or light doors.

SLIDING DOOR TRACK & ACCESSORIES

Assembly #5

PART NUMBER	FOR DOOR THICKNESS	DOOR TYPE	LENGTH	MATERIAL	FINISH
5-BR-3	3/4"	wood	3'	Plastic	Brown
5-BR-4	3/4"	wood	4'	Plastic	Brown
5-BR-5	3/4"	wood	5'	Plastic	Brown
5-BR-6	3/4"	wood	6'	Plastic	Brown
5-G-3	3/4"	wood	3'	Plastic	Gray
5-G-4	3/4"	wood	4'	Plastic	Gray
5-G-5	3/4"	wood	5'	Plastic	Gray
5-G-6	3/4"	wood	6'	Plastic	Gray
5-T-3	3/4"	wood	3'	Plastic	Tan
5-T-4	3/4"	wood	4'	Plastic	Tan
5-T-5	3/4"	wood	5'	Plastic	Tan
5-T-6	3/4"	wood	6'	Plastic	Tan
5-WH-3	3/4"	wood	3'	Plastic	White
5-WH-4	3/4"	wood	4'	Plastic	White
5-WH-5	3/4"	wood	5'	Plastic	White
5-WH-6	3/4"	wood	6'	Plastic	White

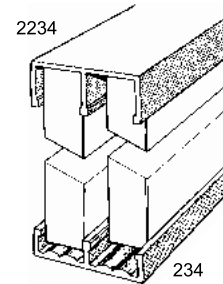

Assembly #5 - High impact, extruded polystyrene plastic track and guide system for 3/4" by-passing doors. Recommended for small and/or light 3/4" doors. Four #33 button glides provide a smooth sliding action.

Assembly #8

PART NUMBER	FOR DOOR THICKNESS	DOOR TYPE	LENGTH	MATERIAL	FINISH
8-A-3	1/4"	wood/glass	3'	Aluminum	Mill Aluminum
8-A-4	1/4"	wood/glass	4'	Aluminum	Mill Aluminum
8-A-5	1/4"	wood/glass	5'	Aluminum	Mill Aluminum
8-A-6	1/4"	wood/glass	6'	Aluminum	Mill Aluminum

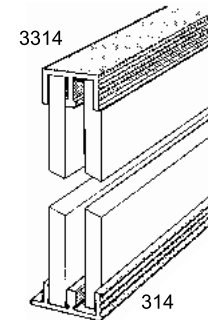

Assembly #8 - Extruded aluminum sliding door track and guide system for heavier 1/4" by-passing doors. Serrated face is designed to provide an attractive finished fascia. Installation screws included.

Assembly #10

PART NUMBER	FOR DOOR THICKNESS	DOOR TYPE	LENGTH	MATERIAL	FINISH
10-A-3	1/2"	wood	3'	Aluminum	Mill Aluminum
10-A-4	1/2"	wood	4'	Aluminum	Mill Aluminum
10-A-5	1/2"	wood	5'	Aluminum	Mill Aluminum
10-A-6	1/2"	wood	6'	Aluminum	Mill Aluminum

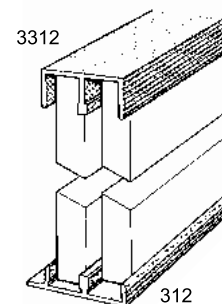

Assembly #10 - Extruded aluminum sliding door track and guide system for heavier 1/2" by-passing doors. Serrated face is designed to provide an attractive finished fascia. Four #33 button glides provide a smooth sliding action. Installation screws included.

Assembly #11

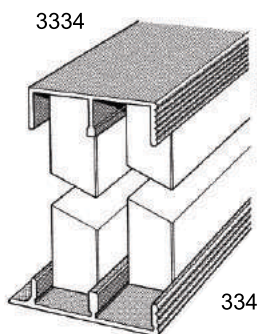

PART NUMBER	FOR DOOR THICKNESS	DOOR TYPE	LENGTH	MATERIAL	FINISH
11-A-3	3/4"	wood	3'	Aluminum	Mill Aluminum
11-A-4	3/4"	wood	4'	Aluminum	Mill Aluminum
11-A-5	3/4"	wood	5'	Aluminum	Mill Aluminum
11-A-6	3/4"	wood	6'	Aluminum	Mill Aluminum

Assembly #11 - Extruded aluminum sliding door track and guide system for heavier 3/4" by-passing doors. Serrated face is designed to provide an attractive finished fascia. Four #33 button glides provide a smooth sliding action. Installation screws included.

Assembly #13

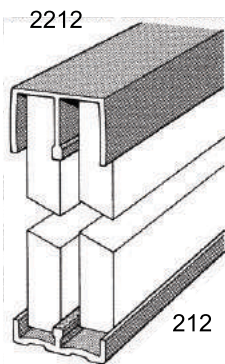

PART NUMBER	FOR DOOR THICKNESS	DOOR TYPE	LENGTH	MATERIAL	COLOR
13-BR-3	1/2"	wood	3'	Plastic	Brown
13-BR-4	1/2"	wood	4'	Plastic	Brown
13-BR-5	1/2"	wood	5'	Plastic	Brown
13-BR-6	1/2"	wood	6'	Plastic	Brown
13-G-3	1/2"	wood	3'	Plastic	Gray
13-G-4	1/2"	wood	4'	Plastic	Gray
13-G-5	1/2"	wood	5'	Plastic	Gray
13-G-6	1/2"	wood	6'	Plastic	Gray
13-T-3	1/2"	wood	3'	Plastic	Tan
13-T-4	1/2"	wood	4'	Plastic	Tan
13-T-5	1/2"	wood	5'	Plastic	Tan
13-T-6	1/2"	wood	6'	Plastic	Tan

Assembly #13 - High impact, extruded polystyrene track and guide system for 1/2" by-passing doors. Recommended for small and/or light 1/2" doors. Four #33 button glides provide a smooth sliding action.

Assembly #14

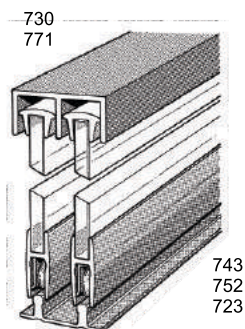

PART NUMBER	FOR DOOR THICKNESS	DOOR TYPE	LENGTH	MATERIAL	FINISH
14-A-3	1/4"	glass	3'	Aluminum	Satin Clear Anodized
14-A-4	1/4"	glass	4'	Aluminum	Satin Clear Anodized
14-A-5	1/4"	glass	5'	Aluminum	Satin Clear Anodized
14-A-6	1/4"	glass	6'	Aluminum	Satin Clear Anodized
14-A-8	1/4"	glass	8'	Aluminum	Satin Clear Anodized
14-ORB-3	1/4"	glass	3'	Aluminum	Oil Rubbed Bronze
14-ORB-4	1/4"	glass	4'	Aluminum	Oil Rubbed Bronze
14-ORB-5	1/4"	glass	5'	Aluminum	Oil Rubbed Bronze
14-ORB-6	1/4"	glass	6'	Aluminum	Oil Rubbed Bronze

Assembly #14 consists of: one 730 upper guide, two 743 shoes, one 723 double track, four 752 nylon rollers, four 771 clip guides, glazing vinyl and mounting screws. Eight foot assembly comes with eight 753 steel rollers and eight 771 clip guides. Option that can be used with assembly #14 include: 730 side jambs, locks, knobs and pulls.

- Recommended for small, light-weight doors.

* For locks to be effective, side jambs must be used.

** For glass height, deduct 1 1/32" from opening height.

SLIDING DOOR TRACK & ACCESSORIES

Assembly #15

PART NUMBER	FOR DOOR THICKNESS	DOOR TYPE	LENGTH	MATERIAL	FINISH
15-A-3	1/4"	glass	3'	Aluminum	Satin Clear Anodized
15-A-4	1/4"	glass	4'	Aluminum	Satin Clear Anodized
15-A-5	1/4"	glass	5'	Aluminum	Satin Clear Anodized
15-A-6	1/4"	glass	6'	Aluminum	Satin Clear Anodized
15-ORB-3	1/4"	glass	3'	Aluminum	Oil Rubbed Bronze
15-ORB-4	1/4"	glass	4'	Aluminum	Oil Rubbed Bronze
15-ORB-5	1/4"	glass	5'	Aluminum	Oil Rubbed Bronze
15-ORB-6	1/4"	glass	6'	Aluminum	Oil Rubbed Bronze

Assembly #15 consists of: one 730 upper guide, two 743 shoes, two 726 double tracks, one 730 track base, four 752 rollers, four 771 clip guides, glazing vinyl and mounting screws. Option that can be used with assembly #15 include: 730 side jambs, locks, knobs and pulls.

* For locks to be effective, side jambs must be used.

** For glass height, deduct 1 1/16" from opening height.

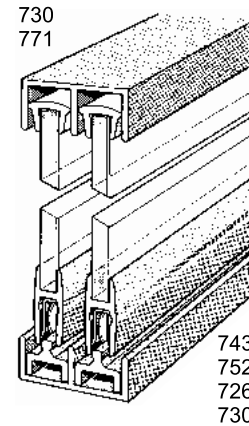

Assembly #16

PART NUMBER	FOR DOOR THICKNESS	DOOR TYPE	LENGTH	MATERIAL	FINISH
16-A-3	1/4"	glass	3'	Aluminum	Satin Clear Anodized
16-A-4	1/4"	glass	4'	Aluminum	Satin Clear Anodized
16-A-5	1/4"	glass	5'	Aluminum	Satin Clear Anodized
16-A-6	1/4"	glass	6'	Aluminum	Satin Clear Anodized

Assembly #16 consists of: one 732 upper guide, two 743 shoes, one 723 double track, one 710-A track base, four 752 rollers, four 771 clip guides, glazing vinyl and mounting screws. Option that can be used with assembly #16 include: 730 side jambs, locks, knobs and pulls.

* For locks to be effective, side jambs must be used.

** For glass height, deduct 1 1/16" from opening height.

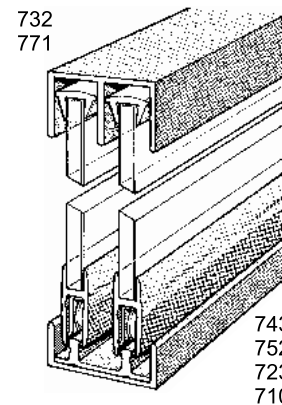

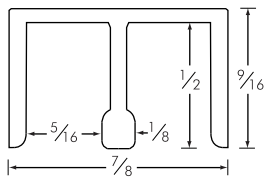

48A14

PART NUMBER LENGTH FINISH

48A14-A	12'	Clear Anodized
---------	-----	----------------

Aluminum upper guide for 1/4" by-passing wood/glass doors. Length=12'. Holes at 6" intervals. For use with: 38SW14-A, 38AS14-A or 810 track.

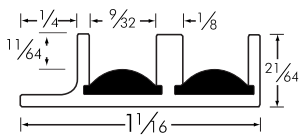

38AS14

PART NUMBER LENGTH FINISH

38AS14-A	12'	Clear Anodized
----------	-----	----------------

Aluminum track for 1/4" by-passing wood/glass doors. For flush mounting. Extruded aluminum with black fibre inserts. Length=12'. For use with: 48A14-A upper guide.

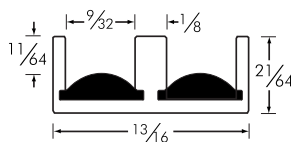

38SW14

PART NUMBER LENGTH FINISH

38SW14-A	12'	Clear Anodized
----------	-----	----------------

Aluminum track for 1/4" by-passing wood/glass doors. For recessed mounting. Extruded aluminum with black fibre inserts. Length=12'. For use with: 48A14-A upper guide.

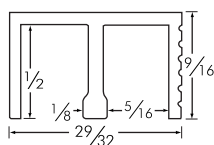

3314

PART NUMBER LENGTH FINISH

3314-M	12'	Mill Aluminum
--------	-----	---------------

Aluminum upper guide for 1/4" by-passing wood/glass doors. Extruded aluminum. Holes at 6" intervals. Serrated face is designed to provide an attractive finished fascia. Length=12'. For use with: 314-M or 810 track.

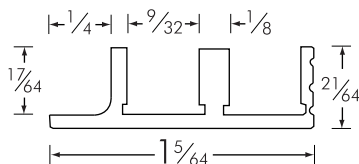

314

PART NUMBER LENGTH FINISH

314-M	12'	Mill Aluminum
-------	-----	---------------

Aluminum track for 1/4" by-passing wood/glass doors. Extruded aluminum. Length = 12'. Holes at 6" intervals. Serrated face is designed to provide an attractive finished fascia. Length=12'. For use with: 3314-M upper guide.

SLIDING DOOR TRACK & ACCESSORIES

PART NUMBER	LENGTH	COLOR
2214-BL	12'	Black
2214-BR	12'	Brown
2214-G	12'	Gray
2214-T	12'	Tan
2214-WH	12'	White

Plastic upper guide for 1/4" by-passing wood/glass doors. High impact, extruded polystyrene. Length=12'. For use with: 214 or 810 track.

2214

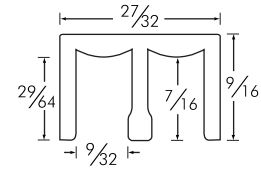

PART NUMBER	LENGTH	COLOR
214-BL	12'	Black
214-BR	12'	Brown
214-G	12'	Gray
214-T	12'	Tan
214-WH	12'	White

Plastic track for 1/4" by-passing wood/glass doors. High impact, extruded polystyrene. Length = 12'. For use with: 2214 upper guide.

214

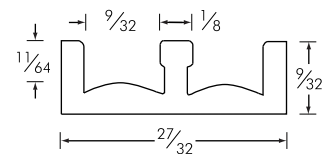

PART NUMBER	LENGTH	COLOR
2212-BR	12'	Brown
2212-G	12'	Gray
2212-T	12'	Tan

Plastic upper guide for 1/2" by-passing wood doors. High impact, extruded polystyrene. Length=12'. For use with: 212, 810, or 801 track.

2212

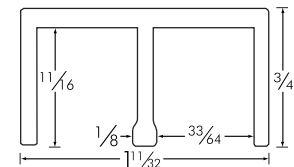

PART NUMBER	LENGTH	COLOR
212-BR	12'	Brown
212-G	12'	Gray
212-T	12'	Tan

Plastic track for 1/2" by-passing wood doors. High impact, extruded polystyrene. Length = 12'. For use with: #33 button glide and 2212 upper guide.

212

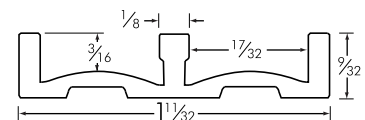

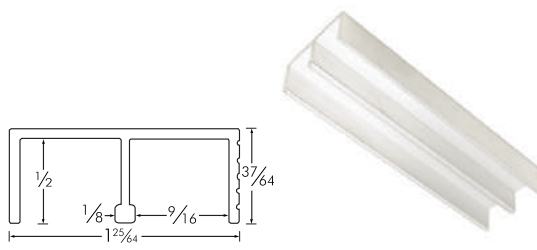

3312

PART NUMBER LENGTH FINISH

3312-M	12'	Mill Aluminum
--------	-----	---------------

Aluminum upper guide for 1/2" by-passing wood doors. Extruded aluminum. Length = 12'. Holes at 6" intervals. Serrated face is designed to provide an attractive finished fascia. For use with: 312-M, 810 or 801 track.

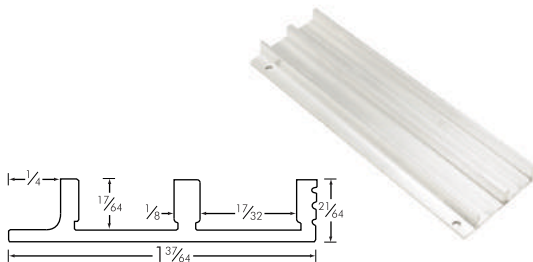

312

PART NUMBER LENGTH FINISH

312-M	12'	Mill Aluminum
-------	-----	---------------

Aluminum track for 1/2" by-passing wood doors. Extruded aluminum. Length = 12'. Holes at 6" intervals. Serrated face is designed to provide an attractive finished fascia. For use with: #33 button glide and 3312-M upper guide.

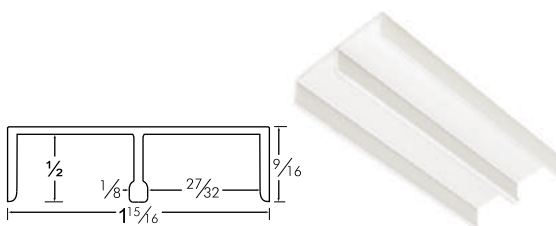

48A34

PART NUMBER LENGTH FINISH

48A34-A	12'	Clear Anodized
---------	-----	----------------

Aluminum upper guide for 3/4" by-passing wood doors. Extruded aluminum. Length=12'. Holes at 6" intervals. For use with: 821-M, 810 or 801 track.

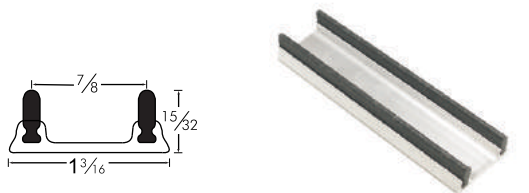

821

PART NUMBER LENGTH MATERIAL

821-M	12'	Fibre/Aluminum
-------	-----	----------------

Aluminum track for 3/4" by-passing doors. Extruded aluminum with black fibre inserts. Holes at 6" intervals. For use with: 1801 fibre glide and 48A34-A upper guide.

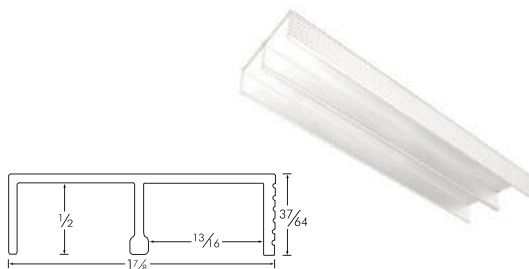

3334

PART NUMBER LENGTH FINISH

3334-M	12'	Mill Aluminum
--------	-----	---------------

Aluminum upper guide for 3/4" by-passing wood doors. Extruded aluminum. Holes at 6" intervals. Serrated face is designed to provide an attractive finished fascia. For use with: 334-M, 810 or 801 track.

SLIDING DOOR TRACK & ACCESSORIES

334

PART NUMBER	LENGTH	FINISH
334-M	12'	Mill Aluminum

Aluminum track for $\frac{3}{4}$ " by-passing wood doors. Extruded aluminum. Length = 12'. Holes at 6" intervals. Serrated face is designed to provide an attractive finished fascia. For use with: #33 button glide and 3334-M upper guide.

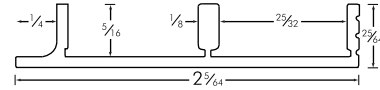

2234

PART NUMBER	LENGTH	COLOR
2234-BR	12'	Brown
2234-G	12'	Gray
2234-T	12'	Tan
2234-WH	12'	White

Plastic upper guide for $\frac{3}{4}$ " by-passing wood doors. High impact, extruded polystyrene. Length=12'. For use with: 234, 801 or 810 track.

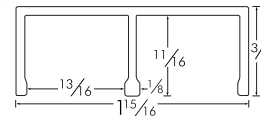
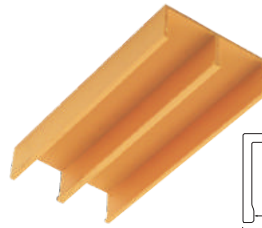

234

PART NUMBER	LENGTH	COLOR
234-BR	12'	Brown
234-G	12'	Gray
234-T	12'	Tan
234-WH	12'	White

Plastic track for $\frac{3}{4}$ " by-passing wood doors. High impact, extruded polystyrene. Length = 12'. For use with: #33 button glide and 2234 upper guide.

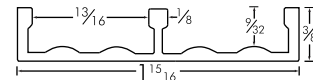

33

PART NUMBER

33

Nylon button glide. Installs into a $\frac{1}{4}$ " diameter hole on the bottom of a $\frac{1}{2}$ " or $\frac{3}{4}$ " door. Use 2 per door. For use with: 212, 234, 312-M or 334-M track.

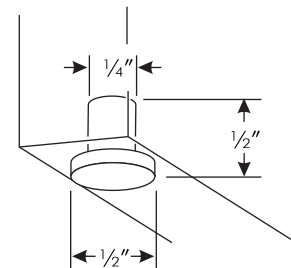

752

PART NUMBER

752



Nylon roller for lighter doors. Press fits into bottom of 743 shoe. (note: for heavier doors, please use 753 steel ball bearing rollers).

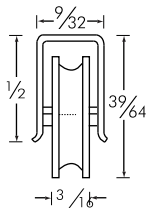

753

PART NUMBER

753



Steel ball bearing roller for heavier doors. Press fits into bottom of 743 shoe.

760

PART NUMBER

COLOR

760	Black
-----	-------



Rubber T-guide. Press fits into 743 shoe to silence operation. Can also be used at the end of 743 shoe as a rubber bumper.

771

PART NUMBER

COLOR

771	Clear
-----	-------

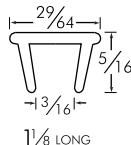

Plastic clip guide. Fits over top of glass for silent operation in upper guide.

780

PART NUMBER

COLOR

780	Black
-----	-------



Rubber bumper. Press fits into a 1/4" diameter hole in side jamb to cushion glass.

2021

PART NUMBER

COLOR

2021	Gray
------	------

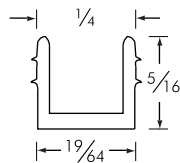

Glazing vinyl. Provides quick, clean and easy installation of 1/4" glass. 100' rolls.

Multiple uses:

- Use to press fit 1/4" glass into top of 743 shoe.
- Use to press fit GP-15 glass door pull onto 1/4" glass.

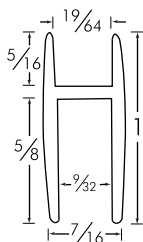

743

PART NUMBER

FINISH

LENGTH MATERIAL

743-A	Satin Clear Anodized	12'	Aluminum
743-ORB	Oil Rubbed Bronze	12'	Aluminum

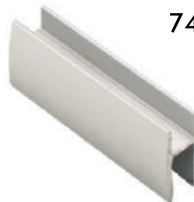

Shoe moulding. 1/4" glass press fits into top of shoe using 2021 glazing vinyl. Rollers press fit into bottom of shoe. Length=12'.

SLIDING DOOR TRACK & ACCESSORIES

PART NUMBER	FINISH	LENGTH	MATERIAL
710-A	Satin Clear Anodized	12'	Aluminum

Use as track base with 723 double track. Extruded aluminum. Length = 12'

710

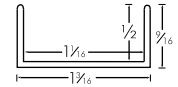

PART NUMBER	FINISH	LENGTH	MATERIAL
723-A	Satin Clear Anodized	12'	Aluminum
723-ORB	Oil Rubbed Bronze	12'	Aluminum

Double track. Can also be used with 710-A base. Extruded aluminum. Length=12'.

723

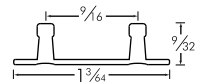

PART NUMBER	FINISH	LENGTH	MATERIAL
725-A	Satin Clear Anodized	12'	Aluminum

Use as track base with 726 single track, as side jambs for single sliding doors or as upper guide for single sliding doors. Extruded aluminum. Length=12'.

725

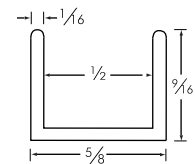

PART NUMBER	FINISH	LENGTH	MATERIAL
726-A	Satin Clear Anodized	12'	Aluminum
726-ORB	Oil Rubbed Bronze	12'	Aluminum

Single track. Can be used with 725-A track base or with 730 track base. Extruded aluminum. Length=12'.

726

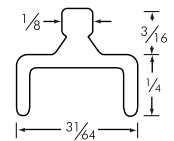

PART NUMBER	FINISH	LENGTH	MATERIAL
730-A	Satin Clear Anodized	12'	Aluminum
730-ORB	Oil Rubbed Bronze	12'	Aluminum

Use as upper guide, as side jambs or as track base for 726 track. Extruded aluminum. Length=12'.

730

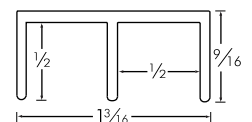

PART NUMBER	FINISH	LENGTH	MATERIAL
732-A	Satin Clear Anodized	12'	Aluminum
732-ORB	Oil Rubbed Bronze	12'	Aluminum

Use as upper guide when using 710-A track base or when greater depth is required. Extruded aluminum. Length=12'

732

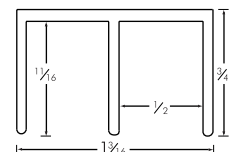

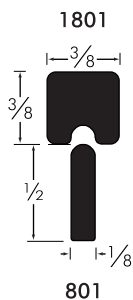

1801

PART NUMBER	LENGTH
1801	1 3/8"

801

PART NUMBER	LENGTH
801-6	6'

- Hardened fibre tracks and glides are self-lubricating to glide smoothly.
- Silent operation
- Durable; no moving parts to wear
- Rust and corrosion proof
- Economical to install
- Doors lift up and out for easy removal.

Black fibre track and glides for use with small, light, wood doors with a thickness of 1/2" and up. Use 801-6 track with 1801 glides (2 per door).

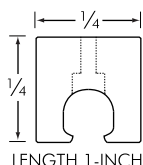

751

PART NUMBER	MATERIAL
751	Nylon

Nylon glide snaps and locks over the rounded edge of the #810 kerf track. Provides a smooth sliding action. Mounts easily into a mortise at each end of door and is secured by a recessed brad. Installation is neat in appearance and free from moving parts to clog or jam.

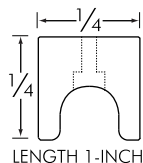

7511

PART NUMBER	MATERIAL
7511	Nylon

Nylon glide for use with 810 kerf track. Provides smooth gliding action. Mounts easily into a mortise at each end of door and is secured by a recessed brad. Installation is neat in appearance and free from moving parts to clog or jam.

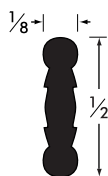

810

PART NUMBER	DESCRIPTION	COLOR
810	Plastic kerf track	Brown

For sliding doors. Packaged 100 ft in dispenser box. Roll out and cut to length. For use on lightweight doors. Simple installation by press fitting into 1/8" saw kerf. Glides, two to a door, are mortised into bottom of door. Sliding action is always sure, easy and quiet. For use with glide 751 or 7511.

SLIDING DOOR TRACK & ACCESSORIES

G03

PART NUMBER **FINISH**

G03-C	Bright Chrome
-------	---------------

Spring activated plunger lock for 1/4" sliding glass doors. Installs into 743 shoe when used with 723 double track. Three keyings available.

Note: Glass must be notched. Can not be used with 710 base track.

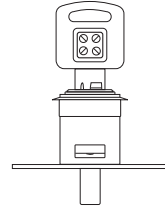

G04

PART NUMBER **FINISH**

G04-C	Bright Chrome
-------	---------------

Ratchet lock for sliding 1/4" glass or wood doors. For overlaps of 3/4" to 3 3/8". Tighten with thumb screw. Four keyings available.

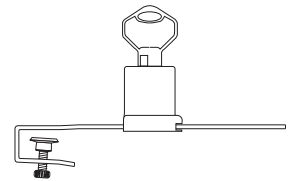

G05

PART NUMBER **FINISH**

G05-C	Bright Chrome
-------	---------------

Lock for sliding 1/4" glass or wood doors. Requires drilling a 5/8" diameter hole for installation.

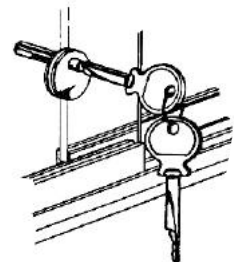

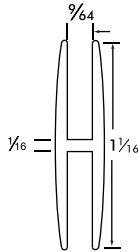

H18

PART NUMBER FINISH

H18-A	Satin Clear Anodized
-------	----------------------

H-Channel for joining 1/8" panels. Adds structural strength and makes neat trim finish. Extruded aluminum. Length=12'.

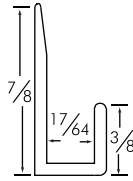

2010

PART NUMBER FINISH

2010-A	Satin Clear Anodized
2010-PA	Polished Aluminum Anodized

Bottom J-Channel for use with 1/4" mirrors. Extruded aluminum. Length=12'.

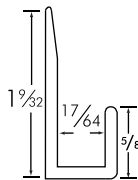

2011

PART NUMBER FINISH

2011-A	Satin Clear Anodized
2011-PA	Polished Aluminum Anodized

Top J-Channel for use with 1/4" mirrors. Extruded aluminum. Length=12'.

MIRROR AND GLASS EXTRUSION

2012

PART NUMBER	FINISH
2012-A	Satin Clear Anodized
2012-ORB	Oil Rubbed Bronze
2012-PA	Polished Aluminum Anodized

Bottom J-Channel with screw ridge. Screw ridge prevents screws from damaging mirror backing. For use with 1/4" mirrors. Extruded aluminum. Length=12'.

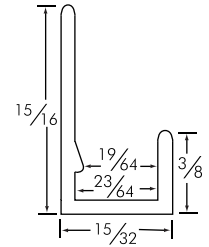

2013

PART NUMBER	FINISH
2013-A	Satin Clear Anodized
2013-PA	Polished Aluminum Anodized

Top J-Channel with screw ridge. Screw ridge prevents screws from damaging mirror backing. For use with 1/4" mirrors. Extruded aluminum. Length=12'.

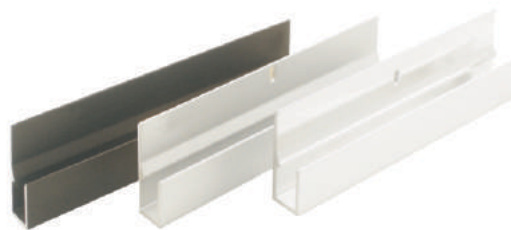
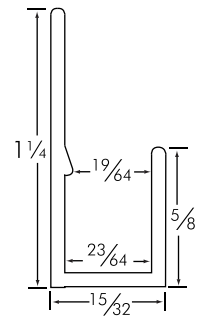

ORB	PA	A
Oil Rubbed Bronze	Polished Aluminum Anodized	Satin Clear Anodized

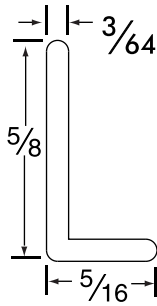

2016

PART NUMBER	FINISH
2016-A	Anodized Aluminum
2016-PA	Polished Aluminum Anodized

L-Channel for use with 1/4" mirrors. 5/8" face makes it ideal for sides of mirror. Extruded aluminum. Length=12'.

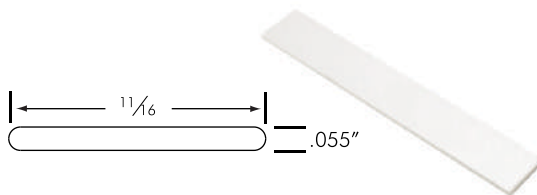

2017

PART NUMBER	FINISH
2017-A	Satin Clear Anodized
2017-ORB	Oil Rubbed Bronze
2017-PA	Polished Aluminum Anodized

Closure strip for trimming mirror seams. Extruded aluminum. Length=12'.

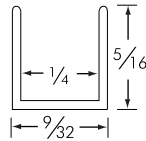

2030

PART NUMBER	FINISH
2030	Bright Annealed Stainless

Protective edge moulding for 1/4" glass. Use on vertical edge of glass in sliding glass door assemblies. Stainless steel, bright annealed. Length=6'.

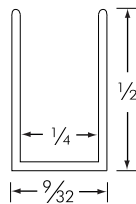

2031

PART NUMBER	FINISH
2031	Bright Annealed Stainless

Protective edge moulding for 1/4" glass. Use on vertical edge of glass in sliding glass door assemblies. Stainless steel, bright annealed. Length=6'.

MIRROR AND GLASS EXTRUSION

2040

PART NUMBER FINISH

2040-A	Satin Clear Anodized
2040-ORB	Oil Rubbed Bronze
2040-PA	Polished Aluminum Anodized

1" L-Channel utility moulding. Length=12'.

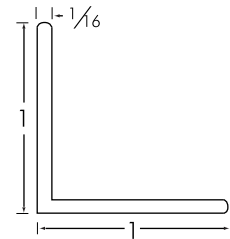

2041

PART NUMBER FINISH

2041-A	Satin Clear Anodized
2041-ORB	Oil Rubbed Bronze
2041-PA	Polished Aluminum Anodized

5/8" L-Channel utility moulding. Length=12'.

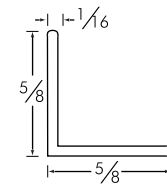

2042

PART NUMBER FINISH

2042-M	Milled Aluminum
--------	-----------------

File drawer rail. Length=12'. Use as an inexpensive alternative to file rail systems.

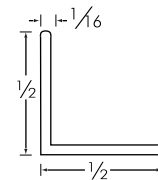

2050

PART NUMBER FINISH

2050-A	Satin Clear Anodized
2050-ORB	Oil Rubbed Bronze

U-Channel utility moulding. Length=12'.

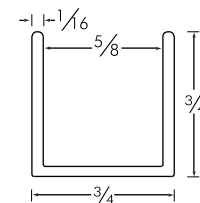

SHELF SUPPORTS AND MIRROR CLIPS

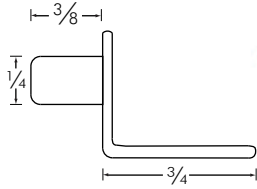

520

PART NUMBER **FINISH**

520-AC	Antique Copper
520-B	Bright Brass
520-N	Bright Nickel

Shelf support with $\frac{1}{4}$ " pin.
Stamped steel.

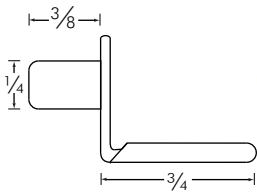

521

PART NUMBER **FINISH**

521-AC	Antique Copper
521-B	Bright Brass
521-N	Bright Nickel

Vinyl covered shelf support with $\frac{1}{4}$ " pin. Stamped steel.

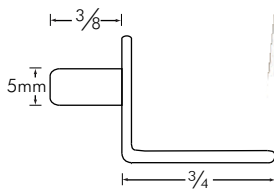

522

PART NUMBER **FINISH**

522-AC	Antique Copper
522-B	Bright Brass
522-N	Bright Nickel

Shelf support with 5mm pin.
Stamped steel.

SHELF SUPPORTS AND MIRROR CLIPS

523

PART NUMBER	FINISH
523-B	Bright Brass
523-N	Bright Nickel

Shelf support with 5mm pin.
Stamped steel.

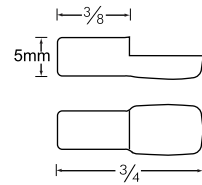

524

PART NUMBER	FINISH
524-B	Bright Brass
524-N	Bright Nickel

Shelf support with 1/4" pin.
Stamped steel.

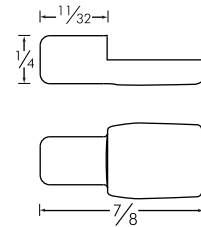

2001

PART NUMBER	PACKAGING
2001-P	Polybagged 6 per pack with screws

Clear plastic mirror clips for 1/4" mirrors.



2004

PART NUMBER	FINISH
2004-BZ	Bronze
2004-PC	Polished Chrome

Glass clip retainer

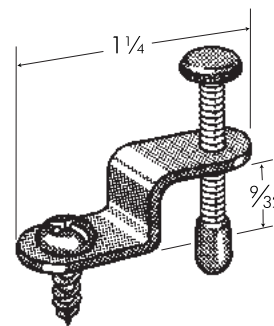

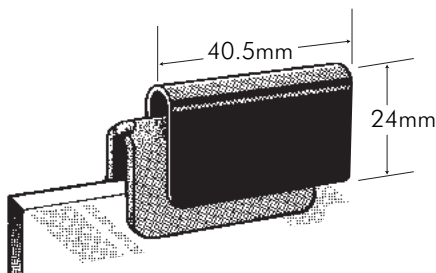

509

PART NUMBER	FINISH
509-BL	Black
509-BN	Brushed Nickel
509-PB	Polished Brass
509-PC	Polished Chrome

Wrap around strike plate for 1/4" and 3/16" glass. For use with 507, 508, 512, 513, 514-BL-PWS and 515-BL-PWS touch latches. Polybagged with stick-on cushion.

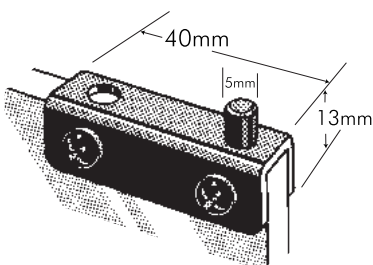

510

PART NUMBER	FINISH
510-BL	Black
510-BN	Brushed Nickel
510-PB	Polished Brass
510-PC	Polished Chrome

Shallow channel glass door hinge for 1/4" and 3/16" glass. Poly-bagged with two hinges, two plastic bushings, two metal plates and screws. Plastic bushings press-fit into 8.5mm hole. The 5mm pin on the hinge fits into the plastic bushing.

GLASS DOOR HARDWARE

516

PART NUMBER	FINISH
516-BL	Black
516-PB	Polished Brass
516-PC	Polished Chrome

Wrap around strike plate with lip for $\frac{1}{4}$ " and $\frac{3}{16}$ " glass. For use with 507, 508, 512, 513, 514-BL-PWS and 515-BL-PWS touch latches. Polybagged with stick-on cushion.

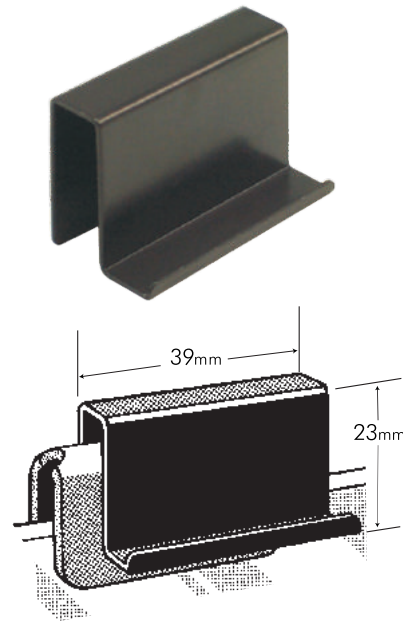

517

PART NUMBER	FINISH
517-BL	Black
517-PB	Polished Brass
517-PC	Polished Chrome

Deep channel glass door hinge for $\frac{1}{4}$ " and $\frac{3}{16}$ " glass. Poly-bagged with two hinges, two plastic bushings, two metal plates and screws. Plastic bushings press-fit into 8.5mm hole. The 5mm pin on the hinge fits into the plastic bushing.

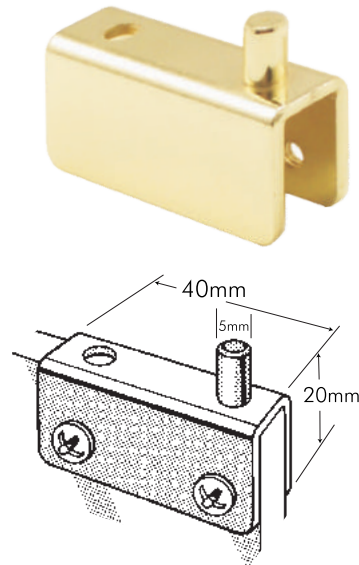



901

PART NUMBER MATERIAL FINISH

901	Solid Brass	Polished Brass
-----	-------------	----------------

Ice box door latch - left hand - 3/8" offset.
Polybagged with bulk screws.



902

PART NUMBER MATERIAL FINISH

902	Solid Brass	Polished Brass
-----	-------------	----------------

Ice box door latch - right hand - 3/8" offset.
Polybagged with bulk screws.



904

PART NUMBER MATERIAL FINISH

904	Solid Brass	Polished Brass
-----	-------------	----------------

Ice box name plate. Polybagged with bulk screws.

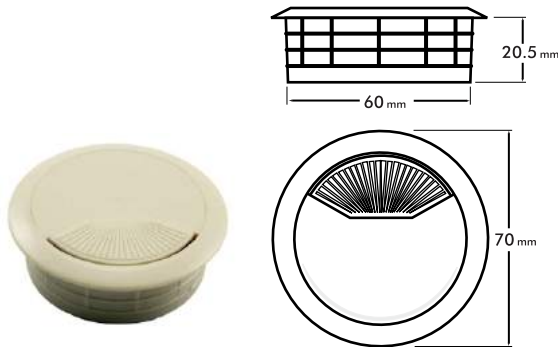

GRS-60

PART NUMBER COLOR

GRS-60-AL	Almond
GRS-60-BL	Black
GRS-60-BR	Brown
GRS-60-G	Grey
GRS-60-WH	White

Plastic cable grommet with spring loaded cover. Two piece.
Requires drilling a 60mm diameter hole.

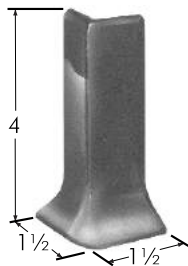

27-4

PART NUMBER

27-4

Plastic corner moulding. Mounts on the corner of table and desk legs to protect against chips and dents.

OTHER FUNCTIONAL HARDWARE

26-E

PART NUMBER

26-E

Lok-level joint clamp. Polybagged with screws.

Joins and levels wood tops and units absolutely flush without glue, dowels or splines.

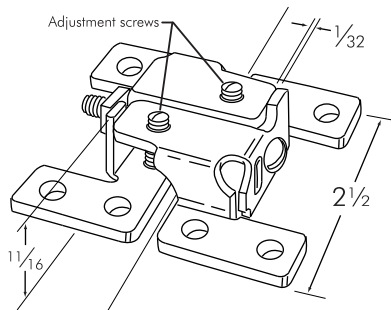
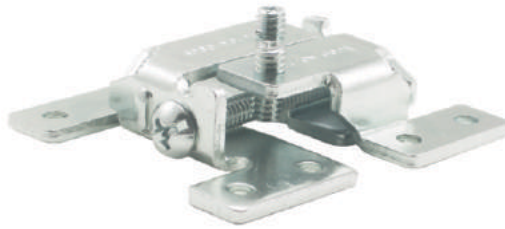

TOP CANNOT "BOW"

Regardless of how tight the locking bolt is drawn, it exerts an even pressure at points "A" and "B" (see sketch) thereby keeping the top absolutely level.

MICROMETER LEVELING ADJUSTMENT

Adjusting screws bear against the steel flange of the opposing member, assuring positive micrometer adjustment to insure a level top.

STUDY CONSTRUCTION

Made of 10 gauge steel (over 1/8" thick).

EASY TO INSTALL

Screw the lok-leveling clamps to under-side of panels at about 6" intervals leaving 1/32" space between clamps to allow for "take up" as shown in sketch at left. Take up on bolts to bring joint together. Do not set up tight until panels are leveled. Use adjusting screws to level entire length of panels. Tighten bolts.

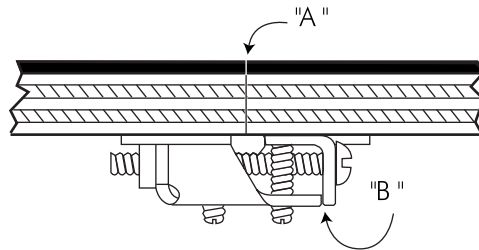

511

PART NUMBER

511

Wood door pivot hinge. Stamped steel. Polybagged with two hinges, two plastic bushing and screws.

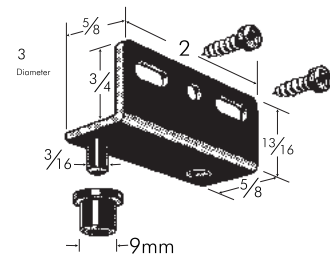



CS

PART NUMBER

CS-50-1-TWH

50mm twin-wheel hooded castor with mounting plate. Black plastic.

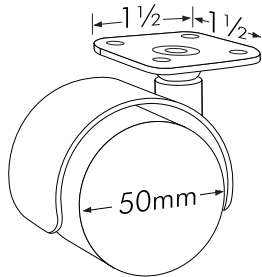

PART NUMBER

TC12

TC

Allows transoms and other overhead hinged panels to drop open to the desired angle. Comes polybagged with screws (8 pan-head 3/4 inch #8 individually polybagged)



- Chain length: 12"
- Plate length: 1 1/2"
- Plate width: 1"
- Made of nickel plated steel

PART NUMBER

CB-3-ZP

CB

Retractable chain bolt for cabinets, screen doors, garage doors, etc. Release the chain, and a strong spring automatically throws the bolt. Mounts either vertically or horizontally and can be used for doors opening in or out. Comes with surface strike for doors opening in, angle strike for doors opening out and screws (6 flat-head and 4 pan-head, 3/4 inch #6 individually polybagged)



- Base length: 2 1/2"
- Base width: 1 1/2"
- Chain length: 26"
- Throw: 1/2"
- Made of zinc plated steel

OTHER FUNCTIONAL HARDWARE

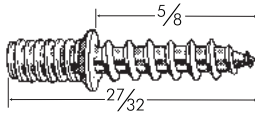

BB

PART NUMBER

BB100

#8-32 machine screw on one end and a #6 x 5/8" wood screw on the other end. For use with knobs and other applications.



SC

PART NUMBER

SC-302

#8 x 1 1/8" phillips truss head self tapping screw for plastic knobs and pulls.

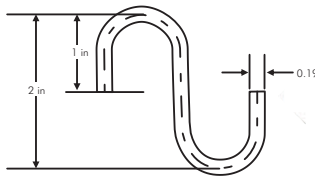

UH-020

PART NUMBER

UH-020-SS

2 inch open utility 'S' hook. Solid 304 stainless steel. One per package.



SH-960

PART NUMBER

MATERIAL

SH-960-SS	Stainless Steel
SH-960-PC	Polished Chrome

- Fits 6 ft span
- * Can be cut to fit 5ft span
- Shower rod and pivoting flanges.

* Available as kit only.

CONDITIONS OF SALE

Sales/Ownership: All sales are expressly conditioned on Buyer's agreement to the terms and conditions set forth below. Any order or statement of intent to purchase goods, or any direction to proceed with procurement or shipment of goods, or any acceptance of or payment for goods shall constitute Buyer's agreement to these terms and conditions. The Engineered Products Company/EPCO Sales, L.L.C. (Seller) hereby gives notice that it objects to any additional or different terms or conditions set forth in Buyer's purchase order or any other communication. No additional or different terms shall apply unless expressly agreed to in writing, and signed by an authorized officer of EPCO. All products become the Buyer's property when delivered to carrier.

Pricing/Taxes: All prices are subject to change without notice, are quoted in U.S. Currency, invoices are payable in U.S. Currency and do not include any form of tax. Taxes imposed by any present or future law of federal, state, county, or municipal authority on the sale of the articles purchased, are required to be paid by the Buyer.

Terms/Payment/Credit: Net 30 days from date of invoice for "Open Credit" accounts. A service charge of 1.5% per month will be added to all past due accounts. Accepted methods of payment, unless otherwise advised: company check, Visa, MasterCard, American Express, Discover, or ACH funds transfer. Non ACH/wire transfer payments are subject to a service fee. Seller reserves the right to convert/process checks into electronic images, which may result in the Buyer's bank account being immediately debited. In the absence of a satisfactory credit rating Seller reserves the right to ship CIA or COD and charge applicable COD fees. Credit Applications can be submitted through our website (www.epcohardware.com) or through our Credit Department at (888) 414-3726 x 207 (M-F 8 AM to 5 PM EST).

New Accounts: All new accounts must make payment arrangements in advance of order shipment via a method outlined supra. Open Account Status shall be given to customers satisfying all of the following requirements: Active status for six months (12 months for new businesses), purchases of at least \$2,500 of EPCO products, and completion and satisfactory evaluation of Credit Application.

Minimum order: \$100 U.S. net. A \$10 service charge will be added to each order with a net billing less than \$100 U.S.

Ordering Methods: Fax (810) 767-5084, email sales@epcohardware.com, Telephone toll-free (888) 414-3726, M-F 8 AM to 5 PM EST

Freight Allowance:

A. Prepaid – An order for \$1500 U.S. or greater, scheduled for shipment at one time to one destination in the contiguous USA.

B. Add - An order less than \$1500 U.S. will have transportation charges added to the invoice.

C. Special Routing - If customer requests special routing, Seller reserves the right to include any additional costs incurred on the invoice.

Warehouse Shipments: Seller reserves the right to make partial shipments of any items ordered unless the order is marked "ship complete." Items not shipped will be back-ordered and Buyer notified. EPCO reserves the right to increase or decrease quantities to make full carton/box shipment.

Shipments Delivered Our Truck: This service is only available in those areas immediately surrounding our

distribution center. A \$50.00 delivery charge will be added (subject to change up or down according to fuel expenses).

Special handling/packaging: If required, an additional charge will be added to the invoice (with pre-approval).

Via Air (next day/second day): These services are available upon request at the full expense of the Buyer.

Outside Continental US: Prepaid and add.

Product Returns/Claims/Defects:

A. All returns must have prior written authorization.

Unauthorized returns will be refused and will be returned to sender at sender's expense.

B. Credit Requests/RGA must be made within 30 days of the date of the invoice. All items for which a RGA has been issued must be in good resalable condition, be in original packaging, properly packaged and shipped pre-paid to the EPCO shipping address. Upon inspection, if the goods are deemed by Seller to be in resalable condition, a credit will be issued less a 25% restocking charge (up to 3 months from invoice date), 50% (3 to 12 months from invoice date). Beyond this time, RGA's will not be issued. Obsolete, discontinued, or special items cannot be returned.

C. Transit Claims - Goods in transit travel at the risk of the purchaser. Damage and/or shortage must be noted upon receipt and be countersigned by the delivering carrier's agent. EPCO will be pleased to furnish any information or assistance needed to establish Buyer's claim against the carrier.

D. Defects – If a product is believed to be defective, please contact EPCO customer service (888) 414-3726.

Limitation of Seller's Liability: Any claim, including claims of defective design, workmanship, or materials, is limited to replacement by shipment of items from Seller's plant, repair, refund, or a combination thereof, as Seller may determine. Seller shall not be liable for damage to the person or property of the Buyer or others caused by product bought from Seller. Seller shall not be liable for any special indirect, incidental, or consequential damages, including (but not limited to) loss of profits or revenue, loss of use of the goods or related goods, damage or injury to the person or property of Buyer or others. Buyer has the obligation to determine the suitability of the goods purchased for Buyer's application. Seller shall not be liable for failure to perform or for delay in performance due to force majeure.

Samples: Will be sent with the handling charge waived; however, freight and merchandise will be charged.

Specials: Any non-stock item manufactured to customer specifications are non-cancelable, non-returnable and are subject to an over or under-run not to exceed 10% of the quantity ordered. All specials require a 50% deposit.

Cutting Charges: Buyer must order in stock lengths and then specify the sizes to be cut from the stock lengths. There will be an additional 10% cutting charge for all plastic and aluminum extrusions that are cut to length (two cuts maximum per extrusion). If more than two cuts are required, please call for a quote. There will be a 15% cutting charge for all stainless steel, steel, and aluminum tubes that are cut to length (one cut maximum per tube). If more than one cut is required, please call for quote.

Caution: Dimensions and measurements are subject to change. Please fabricate or machine your components only to an approved sample. Predrilling hole locations is not recommended. Seller assumes no risk for direct or indirect damages as a result of the Buyer, its agents or end users predrilling, fabricating or machining in advance of receipt of product.

INDEX

PART		PART		PART		PART	
33	PAGE 52	852	PAGE 36	830-90	PAGE 39	DP423	PAGE 17
212	PAGE 50	853	PAGE 36	AC1222	PAGE 6	DP424	PAGE 17
214	PAGE 50	855	PAGE 36	AC2130	PAGE 5	DP425	PAGE 17
234	PAGE 52	856	PAGE 35	AC1232	PAGE 6	DP43	PAGE 9
312	PAGE 51	857	PAGE 37	AC2134	PAGE 5	DP430	PAGE 16
314	PAGE 49	858	PAGE 38	AC2137	PAGE 5	DP433	PAGE 16
334	PAGE 52	859	PAGE 38	AC2138	PAGE 5	DP44	PAGE 10
501	PAGE 27	860	PAGE 36	AC3541	PAGE 6	DP45	PAGE 10
503	PAGE 27	861	PAGE 37	AC367084	PAGE 5	DP46	PAGE 11
504	PAGE 27	863	PAGE 38	AC3822	PAGE 6	DP46-2	PAGE 11
505	PAGE 27	864	PAGE 38	AP-BLACK	PAGE 2	DP47	PAGE 12
507	PAGE 27	865	PAGE 38	AP-SS	PAGE 2	DP48	PAGE 7
508	PAGE 28	870	PAGE 35	AS20	PAGE 2	DP485	PAGE 23
509	PAGE 63	890	PAGE 35	AS38	PAGE 2	DP49	PAGE 7
510	PAGE 63	891	PAGE 35	AS39	PAGE 1	GO3	PAGE 56
511	PAGE 66	895	PAGE 37	AS50	PAGE 1	GO4	PAGE 56
512	PAGE 28	896	PAGE 37	AS51	PAGE 1	GO5	PAGE 56
513	PAGE 28	901	PAGE 65	AS52	PAGE 1	GP-15	PAGE 18
514	PAGE 28	902	PAGE 65	AS53	PAGE 1	GP-17	PAGE 17
515	PAGE 28	904	PAGE 65	AS54	PAGE 1	GP-18	PAGE 17
516	PAGE 64	910	PAGE 33	AS55	PAGE 1	GP-19	PAGE 18
517	PAGE 64	1000	PAGE 31	ASSY #1	PAGE 45	GP-20	PAGE 18
520	PAGE 61	1001	PAGE 31	ASSY #2	PAGE 45	GRS-60	PAGE 65
521	PAGE 61	1003	PAGE 31	ASSY #3	PAGE 45	H18	PAGE 57
522	PAGE 61	1004	PAGE 31	ASSY #5	PAGE 46	KIT830-90	PAGE 39
523	PAGE 62	1006	PAGE 31	ASSY #8	PAGE 46	KP20	PAGE 7
524	PAGE 62	1009	PAGE 32	ASSY #10	PAGE 46	KP30-SS	PAGE 2
541	PAGE 29	1010	PAGE 32	ASSY #11	PAGE 47	KP31-SS	PAGE 2
542	PAGE 29	1011	PAGE 34	ASSY #13	PAGE 47	KP31-ORB	PAGE 4
543	PAGE 29	1012	PAGE 34	ASSY #14	PAGE 47	KP32-ORB	PAGE 4
555	PAGE 29	1013	PAGE 34	ASSY #15	PAGE 48	KP401	PAGE 22
558	PAGE 29	1014	PAGE 32	ASSY #16	PAGE 48	MC302	PAGE 22
590	PAGE 30	1015	PAGE 32	BB	PAGE 68	MC303	PAGE 22
591	PAGE 30	1016	PAGE 33	BP-ORB	PAGE 4	MC304	PAGE 22
592	PAGE 30	1017	PAGE 34	BP-SN	PAGE 3	MC400	PAGE 21
593	PAGE 30	1018	PAGE 33	BP-SS	PAGE 3	MC401	PAGE 19
600	PAGE 30	1801	PAGE 55	BP-VB	PAGE 4	MC402	PAGE 20
710	PAGE 54	2001	PAGE 62	CB	PAGE 67	MC405	PAGE 21
723	PAGE 54	2004	PAGE 62	CH101	PAGE 43	MC427	PAGE 21
725	PAGE 54	2010	PAGE 57	CH102-ORB	PAGE 44	MC428	PAGE 21
726	PAGE 54	2011	PAGE 57	CH105	PAGE 43	SC	PAGE 68
730	PAGE 54	2012	PAGE 58	CH201	PAGE 43	SH-960	PAGE 68
732	PAGE 54	2013	PAGE 58	CH202	PAGE 43	TC	PAGE 67
743	PAGE 53	2016	PAGE 59	CH203-ORB	PAGE 44	TIE-1	PAGE 42
751	PAGE 55	2017	PAGE 59	CH204-ORB	PAGE 44	UH	PAGE 68
752	PAGE 53	2021	PAGE 53	CH301	PAGE 43	VR100	PAGE 42
753	PAGE 53	2030	PAGE 59	CH600	PAGE 44	WL-1000	PAGE 42
760	PAGE 53	2031	PAGE 59	CH800	PAGE 44	WL-800	PAGE 42
771	PAGE 53	2040	PAGE 60	CS	PAGE 67	WL-ARM	PAGE 42
780	PAGE 53	2041	PAGE 60	DP1710	PAGE 23	WP22	PAGE 25
801	PAGE 55	2042	PAGE 60	DP341	PAGE 16	WP23	PAGE 26
810	PAGE 55	2050	PAGE 60	DP40	PAGE 8	WP24	PAGE 26
821	PAGE 51	2212	PAGE 50	DP403	PAGE 12	WP26	PAGE 25
830	PAGE 39	2214	PAGE 50	DP41	PAGE 8	WP28	PAGE 25
831	PAGE 41	2234	PAGE 52	DP4115	PAGE 23	WP29	PAGE 25
840	PAGE 40	3312	PAGE 51	DP412	PAGE 13	WP30	PAGE 25
841	PAGE 40	3314	PAGE 49	DP412-2	PAGE 13	WP31	PAGE 26
842	PAGE 41	3334	PAGE 51	DP413	PAGE 14	WP32	PAGE 26
843	PAGE 40	7511	PAGE 55	DP413-2	PAGE 14	WP34	PAGE 16
844	PAGE 40	26-E	PAGE 66	DP414	PAGE 14	WP36	PAGE 24
845	PAGE 40	27-4	PAGE 65	DP417	PAGE 15	WP37	PAGE 24
847	PAGE 41	38AS14	PAGE 49	DP418	PAGE 15	WP38	PAGE 24
848	PAGE 41	38SW14	PAGE 49	DP419	PAGE 15	ZP402	PAGE 23
850	PAGE 36	48A14	PAGE 49	DP42	PAGE 9		
851	PAGE 37	48A34	PAGE 51	DP422	PAGE 17		



75
SINCE 1941
YEARS

CONTACT US

TOLL FREE (888) 414-3726

TEL (810) 767-2050

FAX (810) 767-5084

MAILING ADDRESS

P.O. BOX 108

FLINT, MI 48501

SHIPPING ADDRESS

601 KELSO STREET

FLINT, MI 48506

WWW.EPCOHARDWARE.COM